

Nightster™ Special - Adversary™ Collection Engine Trim - Graphite

**HARLEY-DAVIDSON®**

# ENGINE TRIM

Build a bike that fits your sense of style. To give your bike a clean and seamless appearance, select components from one of the Harley-Davidson® Engine Trim collections. You'll be one step closer to the look you've been dreaming about.



HARLEY-DAVIDSON® COLLECTIONS



**ADVERSARY™ COLLECTION**  
Black and Orange  
SEE PAGE 424 & 468



**ADVERSARY COLLECTION**  
Graphite Highlighted  
SEE PAGE 425 & 469



**'66 COLLECTION**  
Black  
SEE PAGE 426 & 470



**HARLEY-DAVIDSON® MOTOR CO. COLLECTION**  
Black  
SEE PAGE 430



**HARLEY-DAVIDSON MOTOR CO. COLLECTION**  
Chrome  
SEE PAGE 431



**WILLIE G SKULL COLLECTION**  
Black  
SEE PAGES 432 & 484 - 485



**WILD ONE™ COLLECTION**  
Black  
SEE PAGES 427 & 471



**EMPIRE® COLLECTION**  
Gloss Black  
SEE PAGE 428, 472 - 475



**EMPIRE COLLECTION**  
Machine Cut  
SEE PAGE 428, 472 - 473



**WILLIE G SKULL COLLECTION**  
Chrome  
SEE PAGES 433 & 486 - 487



**END GAME COLLECTION**  
Black  
SEE PAGES 478 - 479



**DOMINION COLLECTION**  
Black or Bronze  
SEE PAGES 480 - 482



**EMPIRE COLLECTION**  
Chrome  
SEE PAGE 428 & 476



**KAHUNA™ COLLECTION**  
Black  
SEE PAGES 429, 488



**KAHUNA™ COLLECTION**  
Chrome  
SEE PAGES 430, 489



**DARK CUSTOM™ COLLECTION**  
Black or Chrome  
SEE PAGE 434 & 435



**AIRFLOW COLLECTION**  
Black or Chrome  
SEE PAGE



**LIVE TO RIDE COLLECTION**  
Chrome  
SEE PAGE



# 424 ENGINE TRIM

Derby, Timer & Air Cleaner Covers

## A. ADVERSARY™ COLLECTION — ANODIZED BLACK WITH ORANGE HIGHLIGHTS

A look to match your riding style – precise, refined and technical. Premium Adversary™ Collection accessories are crafted in forged billet aluminum with a durable dual-anodized black and orange finish for crisp contrast and colorful detail. The look is aggressive and performance driven. Step up to the next generation of customization.

1. **25701536** Derby Cover.  
Fits '16-later Touring and Trike, and '15-later FLHTCUL and FLHTKL models. Also fits '07-later Touring and Trike models equipped with Narrow-Profile Outer Primary Cover P/N 25700385 or 25700438.
2. **25701532** Derby Cover.  
Fits '18-later FLSB and '19-later Softail® models. Also fits '18 Softail models equipped with Narrow Profile Primary Cover P/Ns 25701077, 25700913, 25700937, 25700941, 25701039, 25701040 and 25701043.
3. **25600171** Timer Cover.  
Fits '17-later Milwaukee-Eight® engine-equipped models.
4. **25701164** Alternator Plug Cover.  
Fits '21-later Revolution® Max engine-equipped models.
5. **14101389** Clutch Medallion.  
Fits '21-later Revolution® Max engine-equipped models.
6. **14101393** Timer Medallion.  
Fits '21-later Revolution® Max engine-equipped models.
7. **14101385** Cam Sprocket Medallions.  
Fits '21-later Revolution® Max engine-equipped models.



A. ADVERSARY COLLECTION — DERBY COVER

# ENGINE TRIM 425

Derby, Timer & Air Cleaner Covers

## B. ADVERSARY™ COLLECTION — GRAPHITE WITH MACHINED HIGHLIGHTS

A look to match your riding style – precise, refined and technical. Premium Adversary™ Collection accessories are crafted in forged billet aluminum. The graphite finish with machined highlights reveal brilliant aluminum for crisp contrast and sharp detail. The look is aggressive and performance driven. Step up to the next generation of customization.

1. **25701537** Derby Cover.  
Fits '16-later Touring and Trike, and '15-later FLHTCUL and FLHTKL models. Also fits '07-later Touring and Trike models equipped with Narrow-Profile Outer Primary Cover P/N 25700385 or 25700438.
2. **25701533** Derby Cover.  
Fits '18-later FLSB and '19-later Softail® models. Also fits '18 Softail models equipped with Narrow Profile Primary Cover P/Ns 25701077, 25700913, 25700937, 25700941, 25701039, 25701040 and 25701043.
3. **25600172** Timer Cover.  
Fits '17-later Milwaukee-Eight® engine-equipped models.
4. **25701165** Alternator Plug Cover.  
Fits '21-later Revolution® Max engine-equipped models.
5. **14101390** Clutch Medallion.  
Fits '21-later Revolution® Max engine-equipped models.
6. **14101394** Timer Medallion.  
Fits '21-later Revolution® Max engine-equipped models.
7. **14101386** Cam Sprocket Medallions.  
Fits '21-later Revolution® Max engine-equipped models.



B. ADVERSARY COLLECTION — DERBY COVER

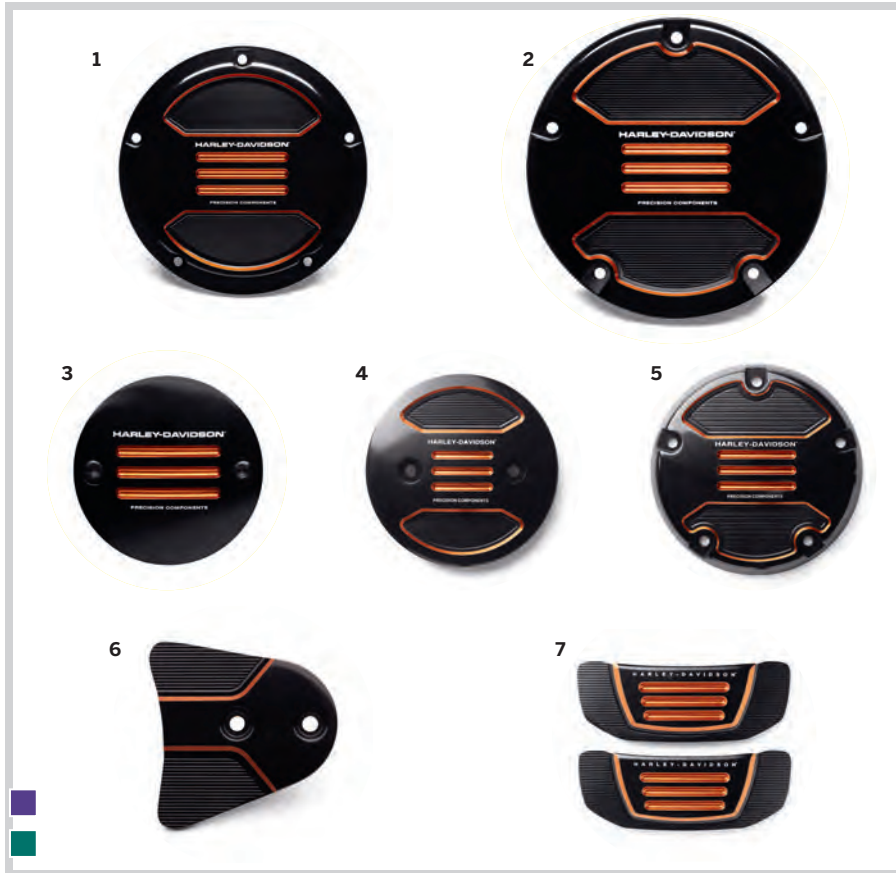

A. ADVERSARY COLLECTION — ANODIZED BLACK WITH ORANGE HIGHLIGHTS

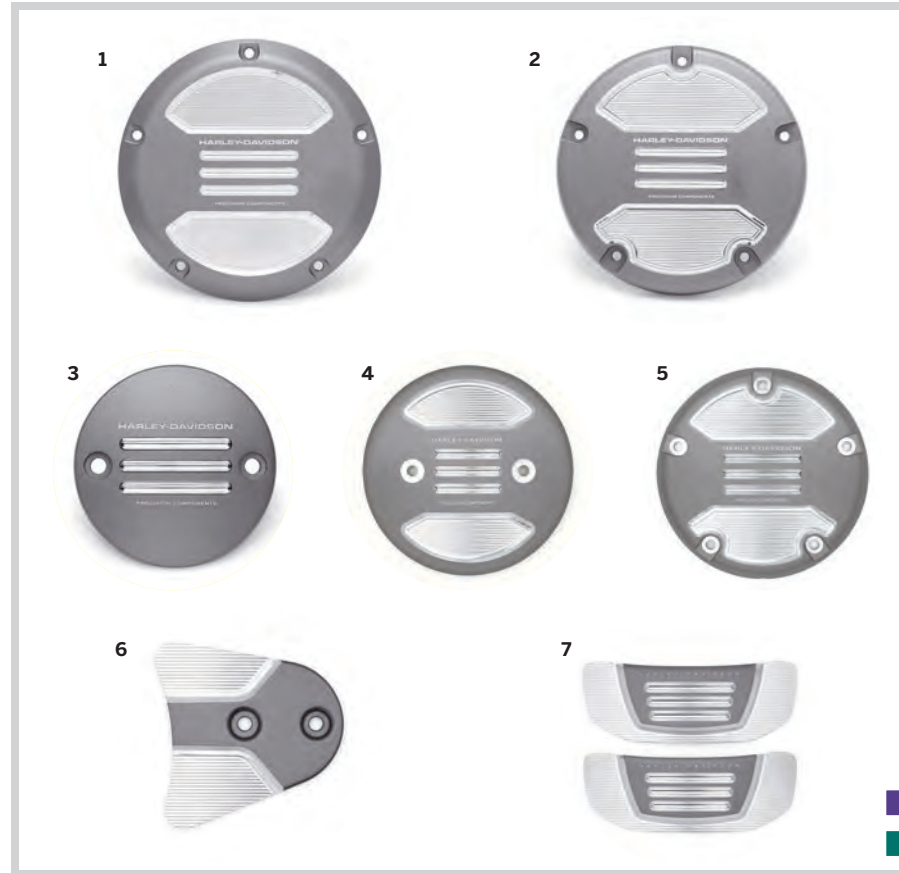

B. ADVERSARY COLLECTION — GRAPHITE WITH MACHINED HIGHLIGHTS

Model Family Fitment:

- V-ROD
- SPORTSTER
- DYNA
- SOFTAIL
- TOURING



# 426 ENGINE TRIM

Derby, Timer & Air Cleaner Covers

## A. '66 COLLECTION

The look is timeless and authentic. The handcrafted style of the '66 Collection accessories combines a durable gloss black finish with brushed aluminum highlights and on most pieces a brass-colored medallion inspired by a classic Harley-Davidson® tank emblem. Here's an alternative to bright chrome or blacked out styles that will set your bike apart from the crowd.

- 1. 25701209** Derby Cover.  
Fits '18-later FLSE and '19-later Softail® models. Also fits '18 Softail models equipped with Narrow Profile Primary Cover P/Ns 25701077, 25700913, 25700937, 25700941, 25701039, 25701040 and 25701043
- 2. 25600156** Timer Cover.  
Fits '17-later Milwaukee-Eight® engine-equipped models.
- 3. 25701211** Alternator Plug Cover.  
Fits '21-later Revolution Max engine-equipped models.
- 4. 14101443** Clutch Medallion.  
Fits '21-later Revolution® Max engine-equipped models.
- 5. 14101445** Timer Medallion.  
Fits '21-later Revolution® Max engine-equipped models.
- 6. 14101615** Cam Sprocket Medallion.  
Fits '21-later Revolution® Max engine-equipped models.



A. '66 COLLECTION – DERBY COVER

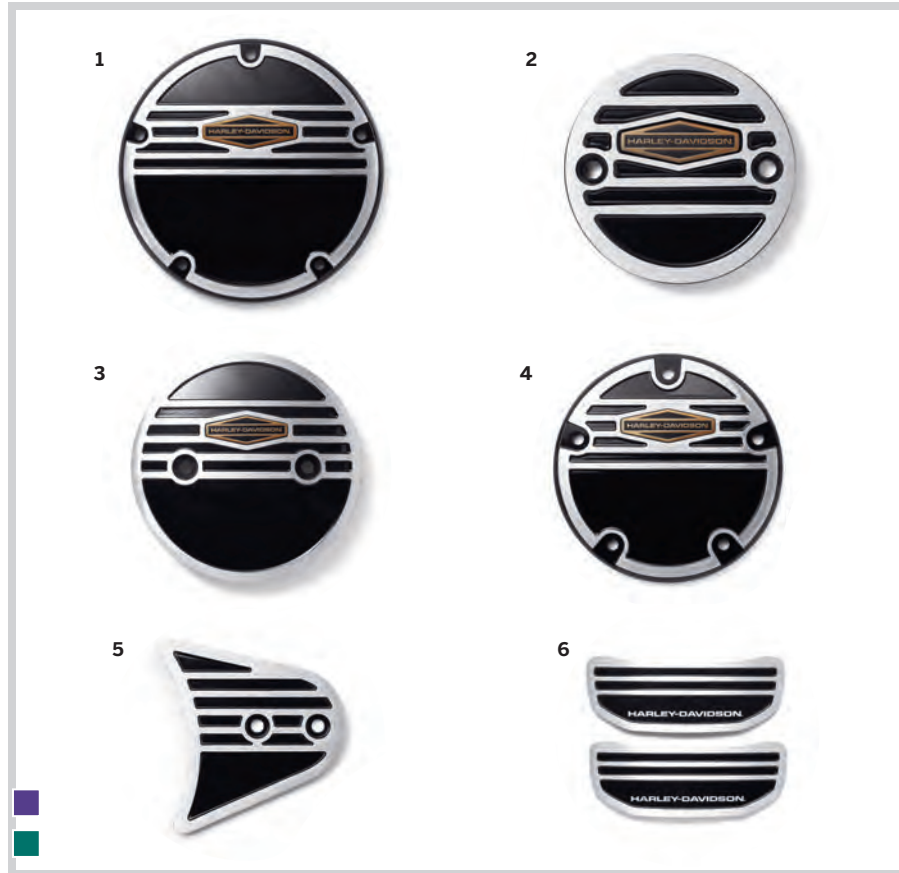

A. '66 COLLECTION

# ENGINE TRIM 427

Derby, Timer & Air Cleaner Covers

## B. WILD ONE™ COLLECTION

Add daring, raw-and-rugged style with durable billet aluminum Wild One™ Collection accessories. Each is finished in gloss black with bright, machined aluminum highlights, a variety of textures and exposed hardware to communicate power, speed, and performance.

- 1. 25701181** Alternator Plug Cover.  
Fits '21-later Revolution® Max engine-equipped models.
- 2. 14101402** Clutch Medallion.  
Fits '21-later Revolution Max engine-equipped models.
- 3. 14101398** Timer Medallion.  
Fits '17-later Milwaukee-Eight® engine-equipped models.
- 4. 14101557** Cam Sprocket Medallions.  
Fits '21-later Revolution® Max engine-equipped models.



B. WILD ONE COLLECTION – ALTERNATOR PLUG COVER.



B. WILD ONE COLLECTION

Model Family Fitment:

- V-ROD
- SPORTSTER
- DYNA
- SOFTAIL
- TOURING



# 428 ENGINE TRIM

Derby, Timer & Air Cleaner Covers

## A. EMPIRE™ COLLECTION — GLOSS BLACK

Raise the stakes. Deep grooves add eye-catching depth and detail to the rich black anodized finish on this complete collection of hand and foot controls. Executed in durable cast and billet aluminum, the Black Empire™ Collection adds captivating custom detail that complements other black and machine cut accessories.

**25701171** Derby Cover.  
Fits '16-later Touring and Trike and '15-later FLTHCUL and FLHTKL models. Also fits '07-later Touring and Trike models equipped with Narrow-Profile Outer Primary Cover P/N 25700385 or 25700438.

**25701177** Derby Cover.  
Fits '18-later FLSB and '19-later Softail® models. Also fits '18 Softail models equipped with Narrow Profile Primary Cover P/N 25700900, 25700913, 25700937, 25700941, 25701039, 25701040 and 25701043.

**25600148** Timer Cover.  
Fits '17-later Milwaukee-Eight® engine equipped models.

## B. EMPIRE™ COLLECTION — BLACK MACHINE CUT

Raise the stakes. Milled highlights reveal gleaming billet aluminum below the rich black anodized surface, while deep grooves add eye-catching depth and detail to each component in this complete collection of hand and foot controls. Executed in durable cast and billet aluminum, the Black Machine Cut Empire™ Collection adds captivating custom detail that complements black or machine cut accessories.

**25701173** Derby Cover.  
Fits '16-later Touring and Trike and '15-later FLTHCUL and FLHTKL models. Also fits '07-later Touring and Trike models equipped with Narrow-Profile Outer Primary Cover P/N 25700385 or 25700438.

**25701179** Derby Cover.  
Fits '18-later FLSB and '19-later Softail® models. Also fits '18 Softail models equipped with Narrow Profile Primary Cover P/N 25700900, 25700913, 25700937, 25700941, 25701039, 25701040 and 25701043.

**25600152** Timer Cover.  
Fits '17-later Milwaukee-Eight® engine equipped models

## C. EMPIRE™ COLLECTION — CHROME

Raise the stakes. Brilliant chrome highlights the deep grooves that add eye-catching depth and detail to this complete collection of hand and foot controls. Executed in durable cast and billet aluminum, the Chrome Empire™ Collection adds captivating custom detail that complements other chrome accessories.

**25701169** Derby Cover.  
Fits '16-later Touring and Trike and '15-later FLTHCUL and FLHTKL models. Also fits '07-later Touring and Trike models equipped with Narrow-Profile Outer Primary Cover P/N 25700385 or 25700438.

**25701175** Derby Cover.  
Fits '18-later FLSB and '19-later Softail® models. Also fits '18 Softail models equipped with Narrow Profile Primary Cover P/N 25700900, 25700913, 25700937, 25700941, 25701039, 25701040 and 25701043.

**25600150** Timer Cover.  
Fits '17-later Milwaukee-Eight® engine equipped models.



A. EMPIRE COLLECTION DERBY COVER — GLOSS BLACK

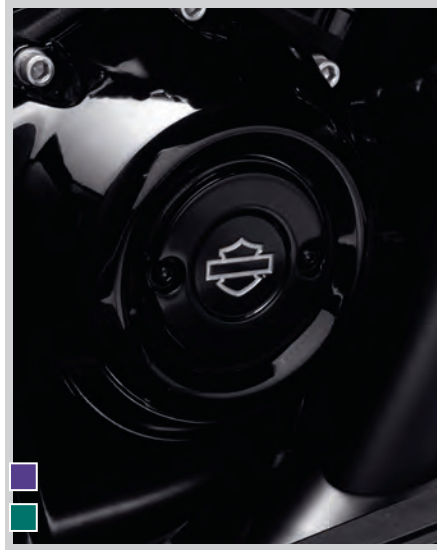

A. EMPIRE COLLECTION TIMER COVER — GLOSS BLACK



B. EMPIRE COLLECTION DERBY COVER — BLACK MACHINE CUT



B. EMPIRE COLLECTION TIMER COVER — BLACK MACHINE CUT



C. EMPIRE COLLECTION DERBY COVER — CHROME



C. EMPIRE COLLECTION TIMER COVER — CHROME



D. KAHUNA COLLECTION DERBY COVER — GLOSS BLACK



E. KAHUNA COLLECTION DERBY COVER — CHROME



D. KAHUNA COLLECTION — GLOSS BLACK



E. KAHUNA COLLECTION — CHROME

# ENGINE TRIM 429

Derby, Timer & Air Cleaner Covers

## D. KAHUNA™ COLLECTION — GLOSS BLACK

Understated but powerful, the Kahuna™ Collection's rich, gloss black surface is interrupted by a powerful raised bridge that draws the eye from leading to trailing edge. A red Bar & Shield logo adds the finishing touch.

**1. 25700887** Derby Cover.  
Fits '16-later Touring and Trike and '15-later FLTHCUL and FLHTKL models. Also fits '07-later Touring and Trike models equipped with Narrow-Profile Outer Primary Cover P/N 25700385 or 25700438.

**2. 25700988** Derby Cover.  
Fits '06-'17 Dyna®, '07-'18 Softail® (except FLSB) and '07-'15 Touring and Trike (except FLTHCUL and FLHTKL and '07-'15 Touring and Trike models equipped with Narrow-Profile Outer Primary Cover P/N 25700385 or 25700438).

**3. 25600109** Timer Cover.  
Fits '17-later Milwaukee-Eight® engine-equipped models.

**4. 25600108** Timer Cover.  
Fits '99-'17 Twin Cam-equipped models.

**5. 61300928** Air Cleaner Trim  
Fits '17-later Touring and Trike models with Original Equipment air cleaner cover. Does not fit CVO™ models.

## E. KAHUNA™ COLLECTION — CHROME

Understated but powerful, the Kahuna™ Collection's smooth, glass-like chrome surface is interrupted by a powerful raised bridge that draws the eye from leading to trailing edge. A red Bar & Shield logo adds the finishing touch.

**1. 25700987** Derby Cover.  
Fits '16-later Touring and Trike and '15-later FLTHCUL and FLHTKL models. Also fits '07-later Touring and Trike models equipped with Narrow-Profile Outer Primary Cover P/N 25700385 or 25700438.

**2. 25700888** Derby Cover.  
Fits '06-'17 Dyna®, '07-'18 Softail® (except FLSB) and '07-'15 Touring and Trike (except FLTHCUL and FLHTKL and '07-'15 Touring and Trike models equipped with Narrow-Profile Outer Primary Cover P/N 25700385 or 25700438).

**3. 25600115** Timer Cover.  
Fits '17-later Milwaukee-Eight® engine-equipped models.

**4. 25600114** Timer Cover.  
Fits '99-'17 Twin Cam-equipped models.

Model Family Fitment:

- V-ROD
- SPORTSTER
- DYNA
- SOFTAIL
- TOURING



# 430 ENGINE TRIM

Derby, Timer & Air Cleaner Covers

## A. HARLEY-DAVIDSON® MOTOR CO. COLLECTION – GLOSS BLACK

An aggressive twist on a classic style. The Harley-Davidson® Motor Co. Collection personifies Harley style and features a rich gloss black surface, trimmed with deep-cut silver-filled lettering that surrounds a central groove. The clean design and the luxurious finish are the perfect match for blacked-out engines. Includes black zinc hardware.

- 1. 25701022** Derby Cover.  
Fits '16-later Touring and Trike and '15-later FLHTCUL and FLHTKL. Also fits '07-later Touring and Trike models equipped with Narrow-Profile Outer Primary Cover P/N 25700385 or 25700438.
- 1. 25701023** Derby Cover.  
Fits '18-later FLSB and '19-later Softail® models. Also fits '18 Softail models equipped with Narrow Profile Primary Cover P/N 25701077, 25700913, 25700937, 25700941, 25701039, 25701040 and 25701043.
- 1. 25701020** Derby Cover.  
Fits '99-'00 Evolution® 1340, '99-'17 Dyna®, '99-'18 Softail (except FLSB) and '99-'15 Touring and Trike models (except FLHTCUL, FLHTKL or '07-'15 Touring or Trike models with Narrow-Profile Outer Primary Cover P/N 25700385 or 25700438).
- 2. 25701021** Derby Cover.  
Fits '04-'22 XL and XR models.
- 3. 25600135** Timer Cover.  
Fits '17-later Milwaukee-Eight® engine-equipped models.
- 4. 25600133** Timer Cover.  
Fits '99-'17 Twin Cam equipped models.
- 5. 25600134** Timer Cover.  
Fits '04-'22 XL, XR and earlier models with horizontal holes on timer cover.
- 6. 61301005** Air Cleaner Trim.  
Fits '18-later FLDE, FLHC, FLHCS, FLSL, FXLR and '20-later FXST models with Original Equipment center bolt air cleaner cover.



A. HARLEY-DAVIDSON MOTOR CO. COLLECTION DERBY COVER – GLOSS BLACK

# ENGINE TRIM 431

Derby, Timer & Air Cleaner Covers

## B. HARLEY-DAVIDSON® MOTOR CO. COLLECTION – CHROME

This collection personifies Harley style. It had better, because we put our name on it—the Harley-Davidson® Motor Co. Collection.

- 1. 25700476** Derby Cover.  
Fits '16-later Touring and Trike, and '15-later FLHTCUL and FLHTKL models. Also fits '07-later Touring and Trike models equipped with Narrow-Profile Outer Primary Cover P/N 25700385 or 25700438.
- 1. 25700959** Derby Cover.  
Fits '18-later FLSB and '19-later Softail® models. Also fits '18-later Softail models equipped with Narrow Profile Primary Cover P/N 25701077, 25700913, 25700937, 25700941, 25701039, 25701040 and 25701043.
- 1. 25338-99B** Derby Cover.  
Fits '99-'00 Evolution® 1340, '99-'17 Dyna®, '99-'18 Softail (except FLSB) and '99-'15 Touring and Trike models (except FLHTCUL, FLHTKL or '07-'15 Touring or Trike models with Narrow-Profile Outer Primary Cover P/N 25700385 or 25700438).
- 2. 25130-04A** Derby Cover.  
Fits '04-'22 XL and XR models. Includes chrome-plated stainless steel mounting hardware.
- 3. 25600068** Timer Cover.  
Fits '17-later Milwaukee-Eight® engine-equipped models.
- 4. 32047-99A** Timer Cover.  
Fits '99-'17 Twin Cam-equipped models. Includes chrome-plated stainless steel mounting hardware.
- 5. 32668-98A** Timer Cover.  
Fits '04-'22 XL, XR and earlier models with horizontal holes on timer cover. Includes chrome-plated stainless steel mounting hardware.
- 6. 61300254** Air Cleaner Trim.  
Fits '16-'17 Softail (except FLSTFBS and FXSE) and '14-'16 Touring and Trike models with Original Equipment air cleaner cover. Does not fit CVO™ models.
- 7. 61300792** Air Cleaner Trim – Center Bolt.  
Fits '18-later FLDE, FLHC, FLHCS, FLSL, FXLR and '20-later FXST models with Original Equipment center bolt air cleaner cover.



B. HARLEY-DAVIDSON MOTOR CO. COLLECTION – CHROME

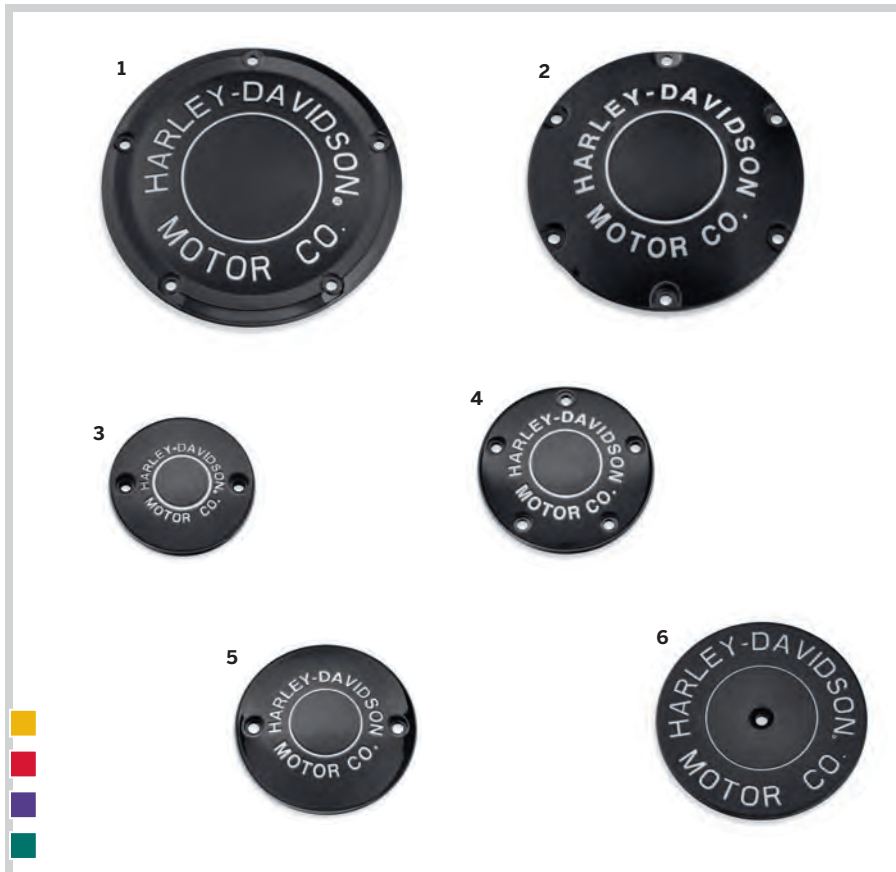

A. HARLEY-DAVIDSON MOTOR CO. COLLECTION – GLOSS BLACK



B. HARLEY-DAVIDSON MOTOR CO. COLLECTION – CHROME

Model Family Fitment:

- V-ROD
- SPORTSTER
- DYNA
- SOFTAIL
- TOURING



## 432 ENGINE TRIM

Derby, Timer & Air Cleaner Covers

### A. WILLIE G SKULL COLLECTION – BLACK

Penned at the hand of Willie G the famous Skull Collection makes a shift to the dark side. Completely drenched in black, the raised skull and surrounding Harley-Davidson® Motorcycle script adds a subtle ominous touch to your ride. The finish easily coexists alongside gloss black or wrinkle black surfaces. The complete collection of components includes matching black hardware.

**1. 25700740** Derby Cover.  
Fits '16-later Touring and Trike and '15-later FLHTCUL and FLHTKL models. Also fits '07-later Touring and Trike models equipped with Narrow-Profile Outer Primary Cover P/N 25700385 or 25700438.

**1. 25700976** Derby Cover.  
Fits '18-later FLSB and '19-later Softail® models. Also fits '18 Softail models equipped with Narrow Profile Primary Cover P/N 25701077, 25700913, 25700937, 25700941, 25701039, 25701040 and 25701043.

**1. 25700742** Derby Cover.  
Fits '99-'17 Dyna®, '00-'18 Softail (except FLSB) and '99-'15 Touring and Trike models (except '15 FLHTCUL and FLHTKL and '07-'15 Touring and Trike models equipped with Narrow-Profile Outer Primary Cover P/N 25700385 or 25700438). Installation on '06-'17 Dyna and '07-later Softail, and '07-'15 Touring and Trike models requires separate purchase of Gasket P/N 25416-99C.

**2. 25700744** Derby Cover.  
Fits '04-'22 XL and XR models.

**3. 25600085** Timer Cover.  
Fits '17-later Milwaukee-Eight® engine-equipped models.

**4. 25600087** Timer Cover.  
Fits '99-'17 Twin Cam models.

**5. 25600089** Timer Cover.  
Fits '04-'22 XL, XR and earlier models with horizontal holes on timer cover.

**6. 29400345** Air Cleaner Trim.  
Fits '17-later Touring and Trike models with Original Equipment wedge shaped air cleaner cover.

**7. 29400366** Air Cleaner Trim.  
Fits Evolution® 1340 models, '99-'08 Dyna, '00-'15 Softail (except FLS, FLSS, FLSTSB, and FXS) and '99-'13 Touring and Trike models equipped with oval-shaped Original Equipment air cleaner cover. Also fits models equipped with Screamin' Eagle® Round High-Flow Air Cleaner Kits with separate purchase of Rain Sock Kit P/N 28728-10 or Air Cleaner Trim Installation Kit P/N 12400158.

**8. 29400339** Air Cleaner Trim.  
Fits '16-'17 Softail (except FLSTFBS and FXSE) and '14-'16 Touring and Trike models with Original Equipment air cleaner cover. Does not fit CVO™ models.

**9. 29400341** Air Cleaner Trim.  
Fits '04-'22 XL models equipped with Original Equipment oval air cleaner cover.



A. WILLIE G SKULL COLLECTION DERBY COVER – BLACK



A. WILLIE G SKULL COLLECTION – BLACK

## ENGINE TRIM 433

Derby, Timer & Air Cleaner Covers

### B. WILLIE G SKULL COLLECTION – CHROME

Add a little attitude to your ride. Styled to complement Harley-Davidson® Skull accessory items, the menacing raised skull with black-filled eyes leaps from a field of chrome. The surrounding Harley-Davidson® Motorcycles script is the perfect finishing touch. This complete collection of engine covers dresses your bike for a true custom look.

**1. 25700469** Derby Cover.  
Fits '16-later Touring and Trike, and '15-later FLHTCUL and FLHTKL models. Also fits '07-later Touring and Trike models equipped with Narrow-Profile Outer Primary Cover P/N 25700385 or 25700438.

**1. 25700958** Derby Cover.  
Fits '18-later FLSB and '19-later Softail® models. Also fits '18 Softail models equipped with Narrow Profile Primary Cover P/N 25701077, 25700913, 25700937, 25700941, 25701039, 25701040 and 25701043.

**1. 25441-04A** Derby Cover.  
Fits '99-'00 Evolution® 1340, '99-'17 Dyna®, '99-'18 Softail (except FLSB) and '99-'15 Touring and Trike models (except FLHTCUL, FLHTKL or '07-'15 Touring or Trike models with Narrow-Profile Outer Primary Cover P/N 25700385 or 25700438).

**2. 25440-04A** Derby Cover.  
Fits '04-'22 XL and XR models. Includes chrome-plated stainless steel mounting hardware.

**3. 25600066** Timer Cover.  
Fits '17-later Milwaukee-Eight® engine-equipped models.

**4. 32975-04A** Timer Cover.  
Fits '99-'17 Twin Cam-equipped models. Includes chrome-plated stainless steel mounting hardware.

**5. 32972-04A** Timer Cover.  
Fits '04-'22 XL, XR and earlier models with horizontal holes on timer cover. Includes chrome-plated stainless steel mounting hardware.

**6. 61300654** Air Cleaner Trim.  
Fits '17-later Touring and Trike models with Original Equipment air cleaner cover. Does not fit CVO™ models.

**7. 29417-04** Air Cleaner Trim.  
Fits Evolution 1340 models, '99-'08 Dyna, '00-'15 Softail (except FLS, FLSS, FLSTSB and FXS) and '99-'13 Touring and Trike models with Original Equipment air cleaner cover. Also fits models equipped with Screamin' Eagle® Round High-Flow Air Cleaner Kits with separate purchase of Rain Sock Kit P/N 28728-10 or Air Cleaner Trim Installation Kit P/N 12400158.

**8. 61300217** Air Cleaner Trim.  
Fits '16-'17 Softail (except FLSTFBS and FXSE) and '14-'16 Touring and Trike models with Original Equipment air cleaner cover. Does not fit CVO™ models.

**9. 29416-04** Air Cleaner Trim.  
Fits '04-'22 XL models with Original Equipment oval air cleaner cover.



B. WILLIE G SKULL COLLECTION DERBY COVER – CHROME



B. WILLIE G SKULL COLLECTION – CHROME

Model Family Fitment:

- V-ROD
- SPORTSTER
- DYNA
- SOFTAIL
- TOURING



# 434 ENGINE TRIM

Derby, Timer & Air Cleaner Covers

## A. DARK CUSTOM™ LOGO COLLECTION

The famous Harley-Davidson #1 logo with a sinister twist. Machined from billet aluminum, these covers feature domed surfaces that are polished and black anodized to a rich satin sheen, and then re-machined to expose the raw aluminum. The resulting high-contrast design complements both polished and painted engine finishes.

**1. 25700434** Derby Cover – Billet.  
Fits '16-later Touring and Trike, and '15-later FLHTCUL and FLHTKL models. Also fits '07-later Touring and Trike models equipped with Narrow-Profile Outer Primary Cover P/N 25700385 or 25700438.

**1. 25700960** Derby Cover.  
Fits '18-later FLSB and '19-later Softail® models. Also fits '18 Softail models equipped with Narrow Profile Primary Cover P/N 25701077, 25700913, 25700937, 25700941, 25701039, 25701040 and 25701043.

**1. 25562-09** Derby Cover – Billet.  
Fits '99-'00 Evolution® 1340, '99-'17 Dyna®, '99-'18 Softail (except FLSB) and '99-'15 Touring and Trike models (except FLHTCUL, FLHTKL or '07-'15 Touring or Trike models with Narrow-Profile Outer Primary Cover P/N 25700385 or 25700438).

**2. 25563-09** Derby Cover – Billet.  
Fits '04-'22 XL models.

**3. 25600064** Timer Cover – Billet.  
Fits '17-later Milwaukee-Eight® engine-equipped models.

**4. 32414-09** Timer Cover – Billet.  
Fits '99-'17 Twin Cam-equipped models.

**5. 32415-09** Timer Cover – Billet.  
Fits '04-'22 XL, XR and earlier models with horizontal holes on timer cover.

**6. 61300057** Air Cleaner Trim – Billet.  
Fits Evolution® 1340 models, '99-'08 Dyna, '00-'15 Softail (except FLS, FLSS, FLSTSB and FXS) and '99-'13 Touring and Trike models with Original Equipment air cleaner cover. Also fits models equipped with Screamin' Eagle® Round High-Flow Air Cleaner Kits with separate purchase of Rain Sock Kit P/N 28728-10 or Air Cleaner Trim Installation Kit P/N 12400158.

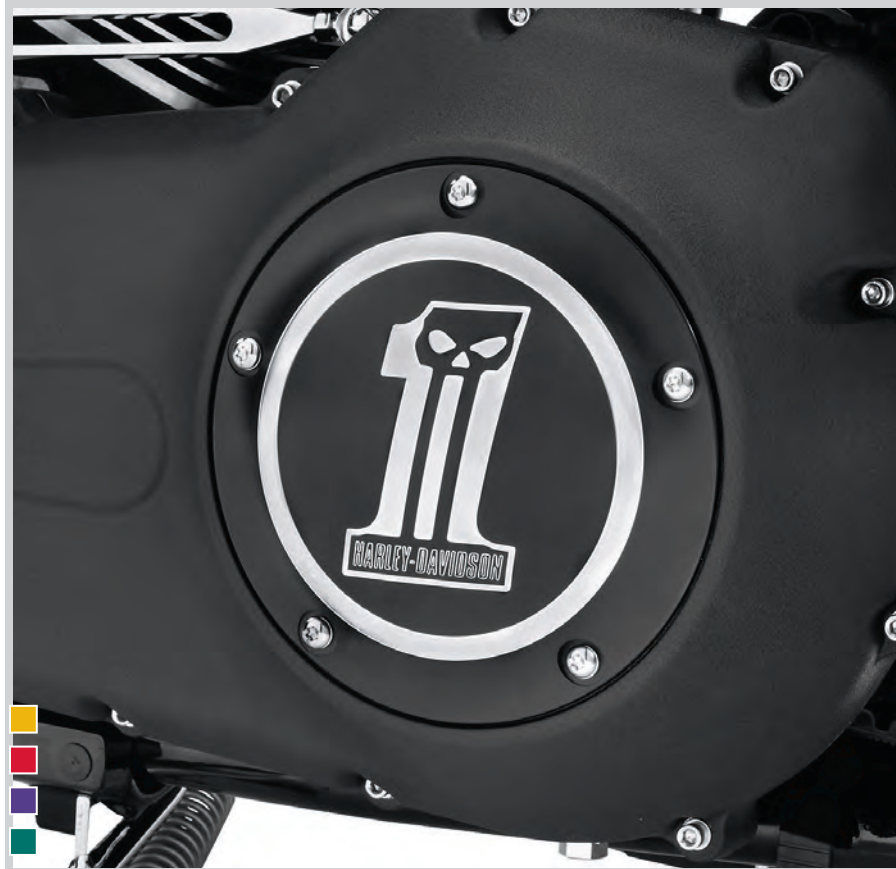

A. DARK CUSTOM LOGO COLLECTION DERBY COVER



B. NUMBER ONE SKULL COLLECTION DERBY COVER

# ENGINE TRIM 435

Derby, Timer & Air Cleaner Covers

## B. NUMBER ONE SKULL COLLECTION

The sinister Harley-Davidson #1 Skull logo dresses for a night on the town. This complete die-cast aluminum collection has been polished and chrome-plated to a brilliant shine, then finished with a contrasting black-filled Dark Custom Skull logo. The black-filled race track stripe and recessed hardware pockets provide added depth and dimension. Includes chrome-plated mounting hardware.

**1. 25700435** Derby Cover – Billet.  
Fits '16-later Touring and Trike, and '15-later FLHTCUL and FLHTKL models. Also fits '07-later Touring and Trike models equipped with Narrow-Profile Outer Primary Cover P/N 25700385 or 25700438.

**1. 25331-10** Derby Cover.  
Fits '99-'00 Evolution® 1340, '99-'17 Dyna®, '99-'18 Softail® (except FLSB) and '99-'15 Touring and Trike models (except FLHTCUL, FLHTKL or '07-'15 Touring or Trike models with Narrow-Profile Outer Primary Cover P/N 25700385 or 25700438).

**2. 25333-10** Derby Cover.  
Fits '04-'22 XL models.

**3. 25600065** Timer Cover.  
Fits '17-later Milwaukee-Eight® engine-equipped models.

**4. 32519-10** Timer Cover.  
Fits '99-'17 Twin Cam-equipped models.

**5. 32520-10** Timer Cover.  
Fits '04-'22 XL, XR and earlier models with horizontal holes on timer cover.

**6. 27956-10** Air Cleaner Trim.  
Fits Evolution® 1340 models, '99-'08 Dyna, '00-'15 Softail (except FLS, FLSS, FLSTSB and FXS) and '99-'13 Touring and Trike models with Original Equipment air cleaner cover. Also fits models equipped with Screamin' Eagle® Round High-Flow Air Cleaner Kits with separate purchase of Rain Sock Kit P/N 28728-10 or Air Cleaner Trim Installation Kit P/N 12400158.

**7. 61300218** Air Cleaner Trim.  
Fits '16-'17 Softail (except FLSTFBS and FXSE) and '14-'16 Touring and Trike models with Original Equipment air cleaner cover. Does not fit CVO models.

**8. 60826-11** Transmission Trim.  
Fits '11-'16 models equipped with 103CI Twin Cam engine option.

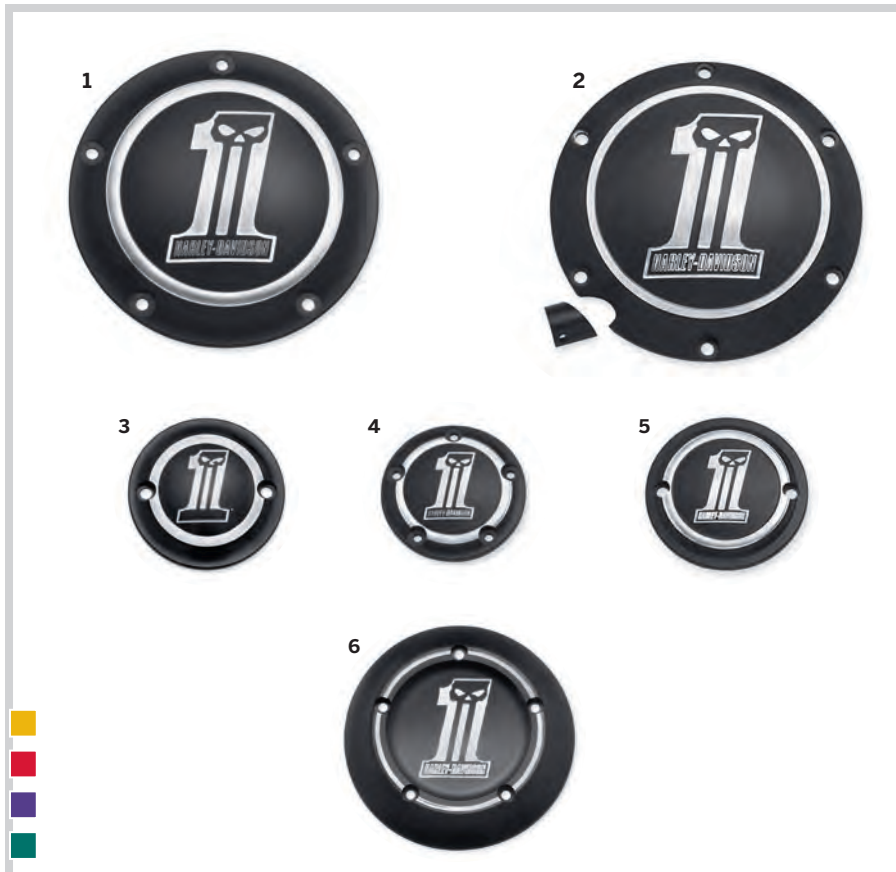

A. DARK CUSTOM LOGO COLLECTION



B. NUMBER ONE SKULL COLLECTION

Model Family Fitment:

- V-ROD
- SPORTSTER
- DYNA
- SOFTAIL
- TOURING



# 436 ENGINE TRIM

Derby, Timer & Air Cleaner Covers

## A. AIRFLOW COLLECTION

Shaped to cheat the wind. The polished and mirror-chromed Airflow Collection features a raised bridge with 3 laminar grooves that float over the recessed panels. The layered surfaces capture light and shadows, and frame the subtle black-filled Harley-Davidson signature. This complete collection sets the stage for your one-of-a-kind custom ride. Includes chrome-plated mounting hardware.

**1. 25700505** Derby Cover.  
Fits '16-later Touring and Trike, and '15-later FLHTCUL and FLHTKL models. Also fits '07-later Touring and Trike models equipped with Narrow-Profile Outer Primary Cover P/N 25700385 or 25700438.

**1. 25700969** Derby Cover.  
Fits '18-later FL5B and '19-later Softail® models. Also fits '18 Softail models equipped with Narrow Profile Primary Cover P/N 25701077, 25700913, 25700937, 25700941, 25701039, 25701040 and 25701043.

**2. 25700504** Derby Cover.  
Fits '99-'17 Dyna®, '00-'18 Softail (except FL5B) and '99-'15 Touring and Trike models (except FLHTCUL, FLHTKL and '07-'15 Touring and Trike models equipped with Narrow-Profile Outer Primary Cover P/N 25700385 or 25700438). Installation on '06-later Dyna, '07-'18 Softail and '07-'15 Touring and Trike models require separate purchase of Gasket P/N 25416-99C.

**3. 25700506** Derby Cover.  
Fits '04-'22 XL models.

**4. 25600099** Timer Cover.  
Fits '17-later Milwaukee-Eight® engine-equipped models.

**5. 25600046** Timer Cover.  
Fits '99-'17 Twin Cam models.

**6. 25600047** Timer Cover.  
Fits '04-'22 XL models.

**7. 61400323** Air Cleaner Trim.  
Fits Evolution® 1340 models, '99-'08 Dyna, '00-'15 Softail (except FLS, FL5S, FL5TSB and FXS) and '99-'13 Touring and Trike models equipped with oval-shaped Original Equipment air cleaner cover. Also fits models equipped with Screamin' Eagle® Round High-Flow Air Cleaner Kits with separate purchase of Rain Sock Kit P/N 28728-10 or Air Cleaner Trim Installation Kit P/N 12400158.

**8. 61300542** Air Cleaner Trim.  
Fits '16-'17 Softail (except FL5TFBS and FXSE) and '14-'16 Touring and Trike models with Original Equipment Air Cleaner Cover. Does not fit CVO™ models.



A. AIRFLOW COLLECTION DERBY COVER

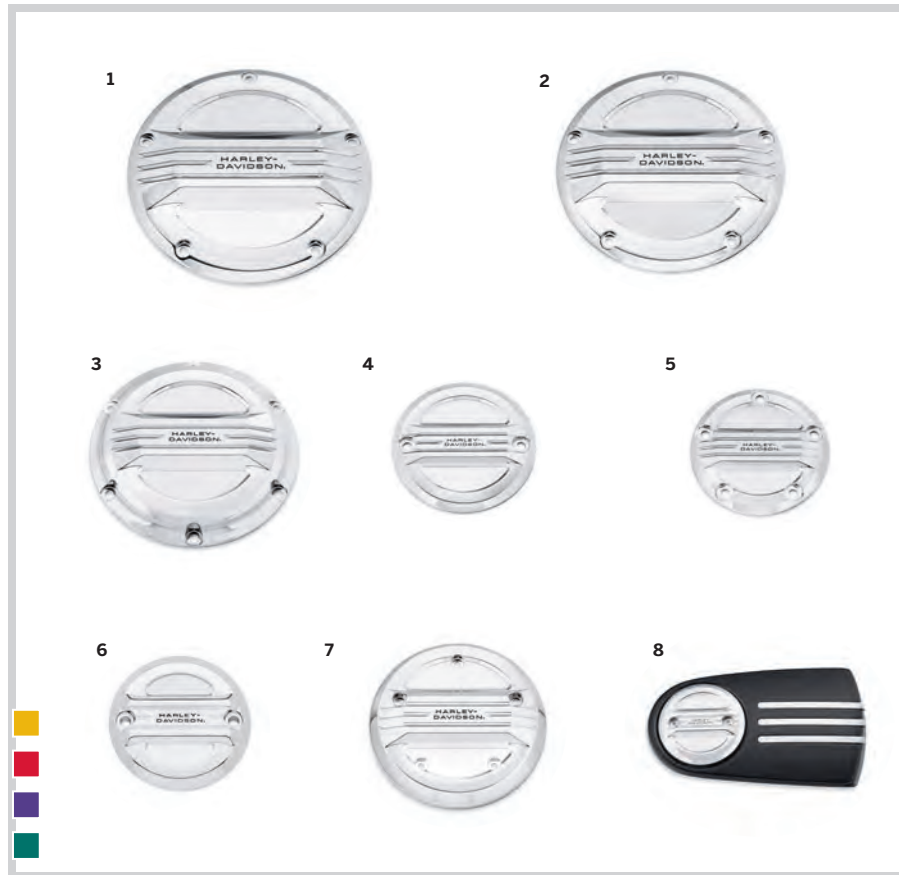

A. AIRFLOW COLLECTION

# ENGINE TRIM 437

Derby, Timer & Air Cleaner Covers

## C. HARLEY-DAVIDSON® LIVE TO RIDE COLLECTION – GOLD

Live to Ride, Ride to Live. It has become the motto of the Harley-Davidson nation, accompanying riders over millions of miles of travel. This collection is a tribute to that way of life.

**1. 25700472** Derby Cover.  
Fits '16-later Touring and Trike, and '15-later FLHTCUL and FLHTKL models. Also fits '07-later Touring and Trike models equipped with Narrow-Profile Outer Primary Cover P/N 25700385 or 25700438.

**1. 25700961** Derby Cover.  
Fits '18-later FL5B and '19-later Softail® models. Also fits '18 Softail models equipped with Narrow Profile Primary Cover P/N 25701077, 25700913, 25700937, 25700941, 25701039, 25701040 and 25701043.

**1. 25340-99A** Derby Cover.  
Fits '99-'00 Evolution® 1340, '99-'17 Dyna®, '99-'18 Softail (except FL5B) and '99-'15 Touring and Trike models (except FLHTCUL, FLHTKL or '07-'15 Touring or Trike models with Narrow-Profile Outer Primary Cover P/N 25700385 or 25700438).

**2. 25127-04A** Derby Cover.  
Fits '04-'22 XL and XR models. Includes chrome-plated stainless steel mounting hardware.

**3. 25600067** Timer Cover.  
Fits '17-later Milwaukee-Eight® engine-equipped models.

**4. 32689-99A** Timer Cover.  
Fits '99-'17 Twin Cam-equipped models. Includes chrome-plated stainless steel mounting hardware.

**5. 32585-90T** Timer Cover.  
Fits models with vertical mounting holes.

**32581-90TB** Timer Cover. (not shown)  
Fits '04-'22 XL, XR and earlier models with horizontal holes on timer cover. Includes chrome-plated stainless steel mounting hardware.

**6. 61300656** Air Cleaner Trim.  
Fits '17-later Touring and Trike models with Original Equipment air cleaner cover. Does not fit CVO™ models.

**7. 29328-99** Air Cleaner Trim.  
Fits Evolution 1340 models, '99-'08 Dyna, '00-'15 Softail (except FLS, FL5TSB and FXS) and '99-'13 Touring and Trike models with Original Equipment air cleaner cover. Also fits models equipped with Screamin' Eagle® Round High-Flow Air Cleaner Kits with separate purchase of Rain Sock Kit P/N 28728-10 or Air Cleaner Trim Installation Kit P/N 12400158.

**8. 61400455** Air Cleaner Trim – Center Bolt.  
Fits '18-later FLDE, FLHC, FLHCS, FL5L, FXLR and '20-later FXST models with Original Equipment center bolt air cleaner cover.

**9. 61400025** Transmission End Cover Trim.  
Fits '11-'16 Touring and Trike models equipped with 103CI Twin Cam engine option.



C. HARLEY-DAVIDSON LIVE TO RIDE DERBY COVER – GOLD



C. HARLEY-DAVIDSON LIVE TO RIDE COLLECTION – GOLD

Model Family Fitment:

- V-ROD
- SPORTSTER
- DYNA
- SOFTAIL
- TOURING



# 438 ENGINE TRIM

Milwaukee-Eight® Collections

## A. GLOSS BLACK ENGINE COVER KIT – MILWAUKEE-EIGHT® POWERTRAIN

Upgrade your black and chrome Milwaukee-Eight® motor to the sinister look of gloss black. Manufactured from Original Equipment components, these richly finished engine covers start your bike on its journey to the dark side. Critical gasket surfaces are masked to provide a good sealing surface with the engine. The six-piece kit includes the primary cover, cam cover, upper rocker box covers, transmission side cover and transmission top cover. Rocker box lower housings, derby cover and timer cover are available separately.

Kit includes:

- Primary Cover
- Cam Cover
- Upper Rocker Box Covers (2)
- Transmission Side Cover with Insert
- Transmission Top Cover

**92500059** Six Piece Engine Cover Kit.  
Fits '17-'20 Touring and Trike models.

## B. MILWAUKEE-EIGHT ENGINE COVERS – GLOSS BLACK

These engine covers are the perfect start in converting your powertrain to an elegant tuxedo black look. Manufactured from Original Equipment components to ensure a perfect fit, these covers are coated with temperature-resistant paint to ensure a long-lasting finish, and critical surfaces are masked to provide good gasket seal. Complete the look with matching primary covers, rocker housings, rocker covers, cam covers and transmission covers (sold separately).

**25700491** Primary Cover.  
Fits '17-later Touring and Trike models.

**25700750** Primary Cover.  
Fits '18 Softail® models (except FLSB, FXBB, FXBBS, , FXLR, FXLRS, and FXLRST).

**25700913** Narrow-Profile Primary Cover.  
Fits '18-later Softail models (except FXST, FXBB, FXBBS, FXLR, FXLRS and FXLRST). '18 models (except FLSB) require separate purchase of Softail Narrow Derby Cover and required gaskets.

**25700467** Cam Cover.  
Fits '18-later Softail and '17-later Touring and Trike models.

**25700520** Rocker Box Cover – Upper.  
Fits '18-later Softail and '17-later Touring and Trike models (2 required).

**25700638** Rocker Box Cover – Lower.  
Fits '18-later Softail and '17-later Touring and Trike models (2 required).

**25800055** Transmission Side Cover.  
Fits '17-'20 Touring and Trike models.

**25800098** Transmission Side Cover  
Fits '18-later Softail and '21-later Touring and Trike models

**34800031** Transmission Top Cover.  
Fits '18-later Softail and '17-later Touring and Trike models. '18-later Softail models require separate purchase of gasket P/N 25700453.

**25700477** Derby Cover.  
Fits '16-later Touring and Trike, and '15-later FLHTCUL and FLHTKL models. Also fits '07-later Touring and Trike models equipped with Narrow-Profile Outer Primary Cover P/N 25700385 or 25700438.

**25700971** Derby Cover.  
Fits '18-later FLSB and '19-later Softail models. Also fits '18 Softail models equipped with Narrow Profile Primary Cover P/Ns 25701077, 25700913, 25700937, 25700941, 25701039, 25701040 and 25701043.

**25600098** Timer Cover.  
Fits '17-later Milwaukee-Eight engine-equipped models.

NOTE: Removing and installing engine covers may require purchase of new gaskets. See dealer for information.



A. GLOSS BLACK ENGINE COVER KIT – MILWAUKEE-EIGHT POWERTRAIN



B. MILWAUKEE-EIGHT ENGINE COVERS – GLOSS BLACK

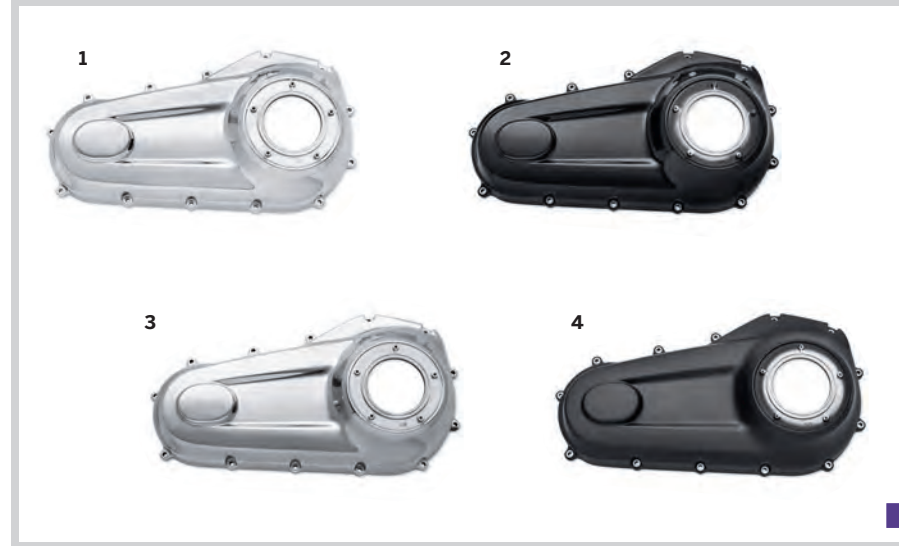

C. NARROW-PROFILE PRIMARY COVERS – FORWARD CONTROLS



D. OE STYLE NARROW-PROFILE DERBY COVERS – '19-LATER SOFTAIL



E. 120TH ANNIVERSARY DECORATIVE COVERS

# ENGINE TRIM 439

Engine Covers – Milwaukee-Eight®

## C. NARROW-PROFILE PRIMARY COVERS – FORWARD CONTROLS

Shaped to slim the bike's left side profile, this Narrow-Profile Primary Cover provide short-limbed riders a straight leg path to the pavement. Original Equipment on '19-later Softail® models.

Fits '18-later Softail models (except FXST, FXBB, FXBBS, FXLR, FXLRS and FXLRST). '18 models (except FLSB) require separate purchase of Softail Narrow Derby Cover and required gaskets.

**1. 25701077** Chrome.

**2. 25700913** Gloss Black.

**3. 25701039** Polished.

**4. 25701043** Wrinkle Black.

Also available:

Fits '18-later FXBB, FXBBS, FXLRS, FXLRST, FXLR and FXST models. '18 models require separate purchase of Softail Derby Cover and required gaskets.

**25700937** Chrome.

**25700941** Wrinkle Black.

## D. OE STYLE NARROW-PROFILE DERBY COVERS – '19-LATER SOFTAIL®

Fits '18-later FLSB and '19-later Softail models. Also fits '18 Softail models equipped with Narrow Profile Primary Cover P/Ns 25701077, 25700913, 25700937, 25700941, 25701039, 25701040 and 25701043.

**1. 25700934** Polished.

**2. 25700970** Black Denim.

**3. 25700971** Gloss Black.

**4. 25700972** Wrinkle Black.

**5. 25700968** Black Fin.

## E. 120TH ANNIVERSARY DECORATIVE COVERS

Celebrate 120 years of Harley-Davidson pride and craftsmanship. This easy-to-install accessory collection is also standard equipment on the limited-edition Harley-Davidson® 120th Anniversary models. Handsome red fade finish with subtle gold and black accents.

**1. 61301326** Air Cleaner Trim.

Fits '17-later Touring and Trike models with Original Equipment wedge shaped air cleaner cover. Does not fit CVO™ models.

**2. 61301327** Air Cleaner Trim.

Fits '18-later Softail and '17-later Touring and Trike models equipped with Ventilator Air Cleaner P/N 29400298 or 29400299. Also fits '18-later Softail® models with 114CI engines and '17-later CVO touring models with Original Equipment Ventilator Air Cleaner with separate purchase of Air Filter P/N 29400293.

**3. 25600176** Timer Cover.

Fits '17-later Milwaukee-Eight engine-equipped models.

Model Family Fitment:

- V-ROD
- SPORTSTER
- DYNA
- SOFTAIL
- TOURING



# 440 ENGINE TRIM

Derby, Timer & Air Cleaner Covers

## A. CLASSIC CHROME COVERS

From the design philosophy of less is more, we bring you this collection of basic chrome accessories, which provides a clean, custom look that is guaranteed to turn heads.

- 1. 25700388** Derby Cover.  
Fits '16-later Touring and Trike, and '15-later FLHTCUL and FLHTKL models. Also fits '07-later Touring and Trike models equipped with Narrow-Profile Outer Primary Cover P/N 25700385 or 25700438.
- 1. 60766-06** Derby Cover. (not shown)  
Fits '06-'17 Dyna® and '07-'18 Softail® (except FLSB), '07-'15 Touring and Trike models (except FLHTCUL, FLHTKL or '07-'15 Touring or Trike models equipped with Narrow-Profile Outer Primary Cover P/N 25700385 or 25700438). Does not fit with passenger footboards in the "medium" or "low" position when flipped up.
- 2. 34760-04** Derby Cover.  
Fits '04-'22 XL models.
- 3. 32584-88TA** Timer Cover.  
Fits '04-'22 XL, XR and earlier models with horizontal holes on timer cover. Includes chrome-plated stainless steel mounting hardware.
- 4. 32679-99A** Timer Cover.  
Fits Twin Cam-equipped models. Includes chrome-plated stainless steel mounting hardware.
- 5. 25600097** Timer Cover.  
Fits '17-later Milwaukee-Eight® engine-equipped models.
- 34761-04A** Chain Inspection Cover. (not shown)  
Fits '04-'22 XL models.
- 6. 60529-90A** Chain Inspection Cover.  
Fits '91-'05 Dyna models (except FXDWG).
- 7. 60572-86** Chain Inspection Cover.  
Fits '93-'05 FXDWG and '86-'06 FLST, FXST and FXSTS models.

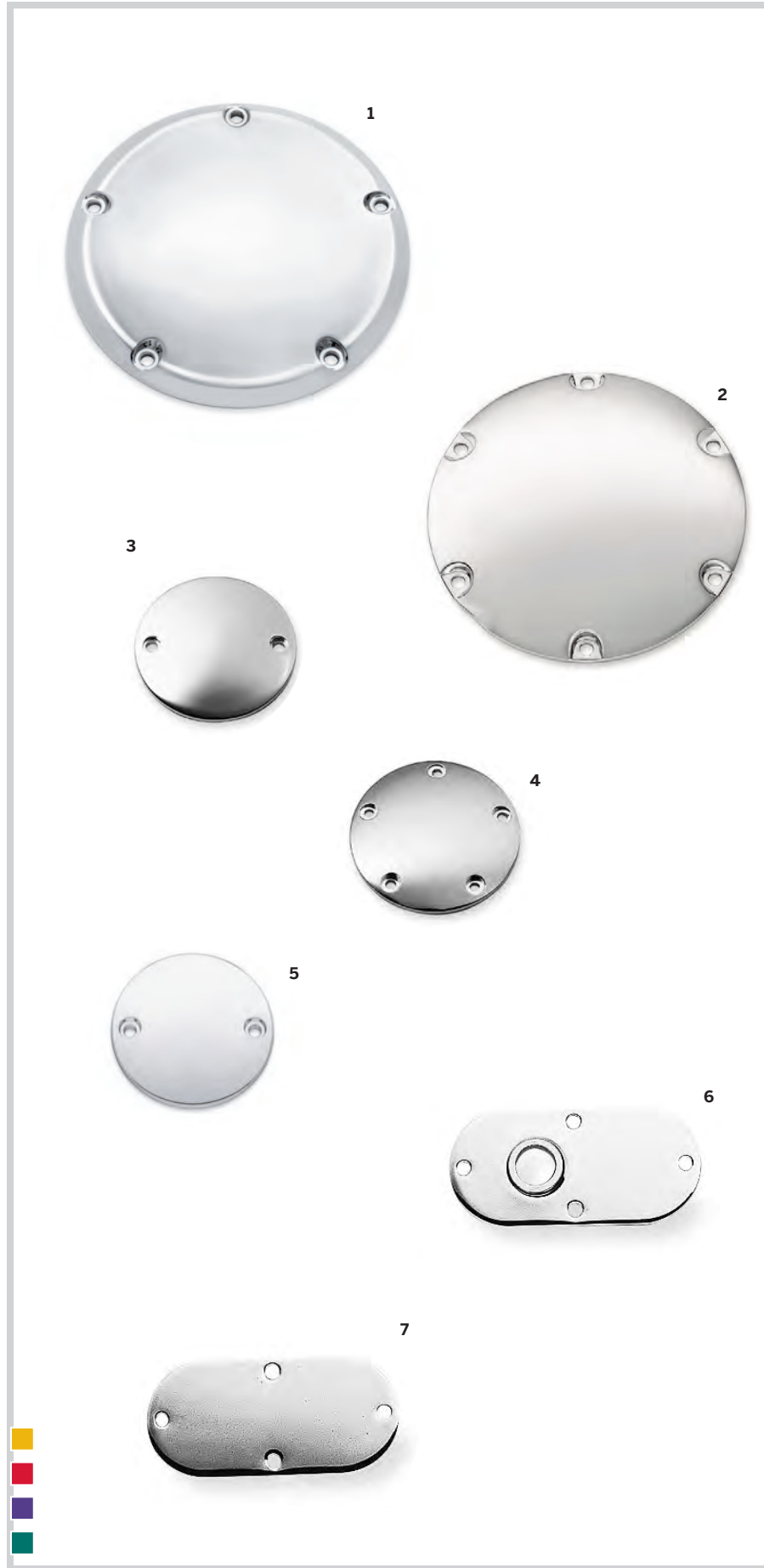

A. CLASSIC CHROME COVERS



B. BLACK FIN COLLECTION



B. BLACK FIN COLLECTION



C. BLACK DERBY COVERS



C. BLACK DERBY COVERS

# ENGINE TRIM 441

Engine Covers – Milwaukee-Eight®

## B. BLACK FIN COLLECTION

Finish the sinister black look of your motorcycle with the Black Fin Collection from Harley-Davidson. The raised horizontal lines on these die-cast covers echo the traditional cylinder fin look, and the wrinkle black finish is a perfect match for the blacked-out primary, cam cover and Finned Headbolt Bridge Kit.

- 1. 25454-01** Derby Cover.  
Fits '99-'00 Evolution® 1340, '99-'17 Dyna®, '99-'18 Softail® (except FLSB) and '99-'15 Touring and Trike models (except FLHTCUL, FLHTKL or '07-'15 Touring or Trike models with Narrow-Profile Outer Primary Cover P/N 25700385 or 25700438).
- 2. 25600142** Timer Cover.  
Fits '17-later Milwaukee-Eight® engine-equipped models.
- 3. 32677-01** Timer Cover.  
Fits '99-'17 Twin Cam-equipped models.

## C. BLACK DERBY COVERS

Available in your choice of wrinkle black or gloss black finish, these simple Derby Covers add a finishing touch to your blacked-out engine.

- Fits '06-'17 Dyna and '07-'18 Softail (except FLSB), and '07-'15 Touring and Trike models (except FLHTCUL, FLHTKL or '07-'15 Touring or Trike models equipped with Narrow-Profile Outer Primary P/N 25700385 or 25700438). Does not fit with passenger footboards in the "medium" or "low" position when flipped up.
- 60713-07** Wrinkle Black.  
**25700020** Gloss Black.
- Fits '16-later Touring and Trike, and '15-later FLHTCUL and FLHTKL models. Also fits '07-later Touring and Trike models equipped with Narrow-Profile Outer Primary Cover P/N 25700385 or 25700438.
- 25700477** Gloss Black.  
Fits '04-'22 XL models.
- 34790-05** Wrinkle Black.

Model Family Fitment:

- |         |           |   |
|---------|-----------|---|
| V-ROD   | SPORTSTER | <span style="color: red;">■</span> DYNA |
| SOFTAIL | TOURING   |   |



# 442 ENGINE TRIM

Engine Covers – Milwaukee-Eight®

## A. MILWAUKEE-EIGHT® ENGINE ACCENT KIT

Get your high-performance engine noticed with this new Milwaukee-Eight® Engine Accent Kit. The kit includes tappet covers, lower rocker box covers, and pushrod collars that add dramatic contrasting color to the powertrain. A great way to detail out an engine upgraded with a Screamin' Eagle® Stage Kit.

Fits '17-later models equipped with Milwaukee-Eight® engine..

**92500122** Orange.

**92500121** Red.



A. MILWAUKEE-EIGHT ENGINE ACCENT KIT – ORANGE



A. MILWAUKEE-EIGHT ENGINE ACCENT KIT – RED

## B. INNER PRIMARY COVER TRIM

Get the look of a custom inner primary cover without tearing apart the drive train. Designed to wrap the top surface of the wrinkle-painted inner primary cover, this die-cast shell provides a beefy finished look to the engine cases. Easy to install, the cover is secured with the outer primary hardware, and held in place at multiple points for quiet operation. Available in your choice of brilliant chrome or gloss black finish, the complete kit includes matching mounting hardware.

Fits '17-later Touring and Trike models.

**25700631** Chrome.

**25700654** Gloss Black.

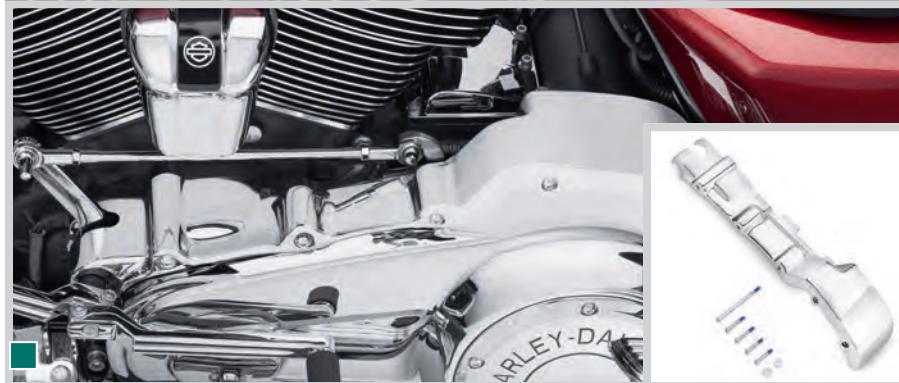

B. INNER PRIMARY COVER TRIM – CHROME

## C. STARTER MOTOR END COVER

It's the details that make the complete custom bike. This starter end cover dresses the end of the starter motor for a clean look. Available in mirror chrome or rich gloss black to match your customizing style.

Fits '17-later Touring and Trike models. Does not fit models equipped with CoolFlow™ Fan P/N 26800120, 26800121 or 26800128.

**31400088** Chrome.

**31400090** Gloss Black.



B. INNER PRIMARY COVER TRIM – GLOSS BLACK



C. STARTER MOTOR END COVER – CHROME



C. STARTER MOTOR END COVER – GLOSS BLACK



D. PUSHROD COVER KIT – GLOSS BLACK (SHOWN WITH TAPPET COVERS – GLOSS BLACK)



D. PUSHROD COVER KIT – GLOSS BLACK



E. TAPPET COVERS – GLOSS BLACK



F. FRONT ENGINE MOUNT STABILIZER LINK



G. FINNED SPARK PLUG COVERS



# ENGINE TRIM 443

Engine Covers – Milwaukee-Eight®

## D. PUSHROD COVER KIT – GLOSS BLACK

Complete the sinister look. These covers replace existing chrome covers to give your bike a blacked-out appearance down to the smallest detail. Pushrod covers are finished in gloss black and the kit includes the four bottom cover tubes, four upper clips and four center collars. Cover Kit can be installed on engines already equipped with Adjustable Pushrods or can be installed by removing rocker box covers, rocker arms and non-adjustable pushrods. Consult your dealer or service manual for installation.

**17900081**

Fits '17-later Milwaukee-Eight® engine-equipped models. Requires prior installation of Adjustable Pushrods or removal of rocker box covers, rocker arms and fixed-length pushrods.

## E. TAPPET COVERS – GLOSS BLACK

Complete your Twin Cam engine's conversion to a total blacked-out look. These gloss black tappet blocks replace the stock bright-finished components for a sinister appearance, and are manufactured from Original Equipment components for perfect fit and function. Gasket surface has been masked to ensure good oil seal. Kit comes complete with a front and rear cylinder lifter covers and two base gaskets.

**25700890**

Fits '17-later Milwaukee-Eight engine-equipped models. Sold in pairs.

## F. FRONT ENGINE MOUNT STABILIZER LINK

Add a custom style to the front end with this brilliant chrome-plated Engine Mount Stabilizer Link. This custom heim joint assembly complements the chrome Billet Front Engine Mount Bracket P/N 16205-10. Kit includes chrome mounting hardware.

Fits '09-later Touring and Trike models.

**16213-10** Chrome.

**16400055** Black.

## G. FINNED SPARK PLUG COVERS

Complete the finned look from the base of the cylinder all the way to the rocker box. These aluminum Finned Spark Plug Covers fill the spark plug pockets and complete the horizontal fin look across the top of the left-hand side of the engine. Firmly held in place by spring clips, these easy-to-install finned covers slip into position and do not require removal of the spark plugs for installation. Sold in pairs.

Fits '17-later Milwaukee-Eight engines.

**25800061** Black.

Model Family Fitment:

- V-ROD
- SPORTSTER
- DYNA
- SOFTAIL
- TOURING



# 444 ENGINE TRIM

Engine Covers – Twin Cam

## A. TWIN CAM ENGINE COVERS – GLOSS BLACK

These engine covers are the perfect start in converting your powertrain to an elegant tuxedo black look. Manufactured from Original Equipment components to ensure a perfect fit, these covers are masked and coated with temperature-resistant paint to ensure a long-lasting finish. Complete the look with matching primary covers, rocker housings, rocker covers, cam covers and transmission covers (sold separately).

**60876-11A** Primary Cover.  
Fits '07-'17 Softail® models. Also fits '06-'17 FLD and Dyna® models equipped with factory forward controls. Will not fit with Accessory Forward Controls.

**60886-11A** Primary Cover.  
Fits '07-'15 Touring and Trike models (except FLHTCUL and FLHTKL).

**25700438** Narrow Primary Cover.  
Fits '07-'16 Touring and Trike models. Installation requires separate purchase of narrow derby cover, derby cover gasket and primary gasket. Chrome is Original Equipment on '15-'16 FLHTCUL and FLHTKL and '16 Touring and Trike models.

**17707-11** Rocker Box Cover.  
Fits '99-'17 Dyna, '00-'17 Softail, and '99-'16 Touring and Trike models (2 required).

**17709-11** Rocker Box Lower Housing.  
Fits '99-'17 Dyna, '00-'17 Softail, and '99-'16 Touring and Trike models (2 required).

**37198-11** Cam Cover.  
Fits '01-'17 Dyna, Softail and '01-'16 Touring and Trike models (except '01 EFI Touring).

**37193-11** Transmission Side Cover.  
Fits '06-'17 Dyna, and '07-'17 Softail (except FLSS, FLSTFBS, FXCW, FXCWC, FXSB and FXSE), and '07-'16 Touring and Trike models. Does not fit models equipped with a hydraulic clutch.

**25700180** Transmission Side Cover.  
Fits '13-'16 Touring and Trike models equipped with hydraulic clutch.

**37195-11** Transmission Top Cover.  
Fits '06-'17 Dyna and '07-later Softail and '07-'16 Touring and Trike models.

**25700020** Derby Cover.  
Fits '06-'17 Dyna and '07-'18 Softail (except FL5B) and '07-'15 Touring and Trike models (except FLHTCUL, FLHTKL or '07-'15 Touring or Trike models equipped with Narrow-Profile Outer Primary Cover P/N 25700385 or 25700438).

**25700477** Derby Cover.  
Fits '16-later Touring and Trike, and '15-later FLHTCUL and FLHTKL models. Also fits '07-later Touring and Trike models equipped with Narrow-Profile Outer Primary Cover P/N 25700385 or 25700438.

NOTE: Removing and installing engine covers may require purchase of new gaskets. See dealer for information.



A. TWIN CAM ENGINE COVERS – GLOSS BLACK



A. TWIN CAM ENGINE COVERS – GLOSS BLACK



B. TWIN CAM ENGINE COVERS – WRINKLE BLACK



B. TWIN CAM ENGINE COVERS – WRINKLE BLACK

# ENGINE TRIM 445

Engine Covers – Twin Cam

## B. TWIN CAM ENGINE COVERS – WRINKLE BLACK

These black powder-coated engine covers are the perfect start in converting your powertrain to a striking wrinkle black look. Manufactured from Original Equipment components, these covers are masked and painted on the factory production paint line to ensure a matching wrinkle black or texture black finish and a perfect fit. Complete the blacked-out look with matching primary covers, rocker housings, rocker covers, cam covers and transmission covers (sold separately).

**60758-06A** Primary Cover.  
Fits '06-'17 Dyna® models with mid controls.

**60717-07A** Primary Cover.  
Fits '07-'17 Softail® models. Also fits '06-'17 FLD and Dyna models equipped with factory forward controls.

**60706-09A** Primary Cover.  
Fits '07-'15 Touring and Trike models (except FLHTCUL or FLHTKL).

**60715-99B** Primary Cover.  
Fits '99-'05 Dyna and '99-'06 Softail models.

**17620-99** Rocker Box Cover.  
Fits '99-'17 Dyna, '00-'17 Softail and '99-'16 Touring and Trike models (2 required).

**17618-99A** Rocker Box Lower Housing.  
Fits '99-'17 Dyna, '00-'17 Softail and '99-'16 Touring and Trike models (2 required).

**25364-01B** Cam Cover.  
Fits '01-'17 Dyna, Softail and '01-'16 Touring and Trike models (except '01 EFI Touring).

**37135-06** Transmission Side Cover.  
Fits '06-'17 Dyna, '07-'17 Softail (except FLSS, FLSTFBS, FXCW, FXCWC, FXSB and FXSE), and '07-'16 Touring and Trike models. Does not fit models equipped with a hydraulic clutch.

**37189-99** Transmission Side Cover.  
Fits '99-'05 Dyna, '00-'06 Softail and '99-'06 Touring models.

**34521-06B** Transmission Top Cover.  
Fits '06-'17 Dyna and '07-'17 Softail, '07-'16 Touring and Trike models.

**60713-07** Derby Cover.  
Fits '06-'17 Dyna and '07-'18 Softail (except FL5B), and '07-'15 Touring and Trike models (except FLHTCUL, FLHTKL or '07-'15 Touring or Trike models equipped with Narrow-Profile Outer Primary Cover P/N 25700385 or 25700438).

NOTE: Removing and installing engine covers may require purchase of new gaskets. See dealer for information.

Model Family Fitment:

- V-ROD
- SPORTSTER
- DYNA
- SOFTAIL
- TOURING



# 446 ENGINE TRIM

Engine Covers – Twin Cam

## A. TWIN CAM ENGINE COVERS – CHROME

Dress the engine of your Twin Cam-equipped model in chrome. These chrome-plated components are manufactured to Original Equipment specifications for exact fit and finish.

### Outer Primary Covers

#### 60764-06A

Fits '06-'17 Dyna® models with mid controls.

#### 60782-06A

Fits '06-'17 Dyna models with forward controls and '07-'17 Softail® models.

#### 60553-07A

Fits '07-'15 Touring and Trike models (except FLHTKL and FLHTCUL).

#### 25700385

Narrow-Profile.

Fits '07-'16 Touring and Trike models. Installation requires separate purchase of narrow derby cover, derby cover gasket and primary gasket. Chrome is Original Equipment on '15-'16 FLHTCUL and FLHTKL and '16 Touring and Trike models.

#### 60543-99B

Fits '99-'05 Dyna and '99-'06 Softail models.

#### 60665-99B

Fits '99-'06 Touring models. Fits '94-'98 Touring models when used with Clutch Cover P/N 60668-99 and Gasket P/N 25416-99C.

### Cam Covers

#### 25369-01B

Fits '01-'17 Dyna, Softail, and '01-'16 Touring and Trike models. (except '01 EFI Touring).

### Transmission Side Covers

#### 37116-06

Fits '06-'17 Dyna, and '07-'17 Softail (except FLSS, FLSTFBS, FXCW, FXCWC, FXSB and FXSE), and '07-'16 Touring and Trike models. Does not fit models equipped with a hydraulic clutch.

#### 37105-99

Fits '99-'05 Dyna, '00-'06 Softail and '99-'06 Touring models.

### Rocker and Tappet Covers

Fits '99-'17 Dyna, '00-'17 Softail and '99-'16 Touring and Trike models.

#### 17572-99

Rocker Cover.

#### 17573-99A

Lower Rocker Housing.

#### 17964-99

Tappet Cover, Front.

#### 17966-99

Tappet Cover, Rear.

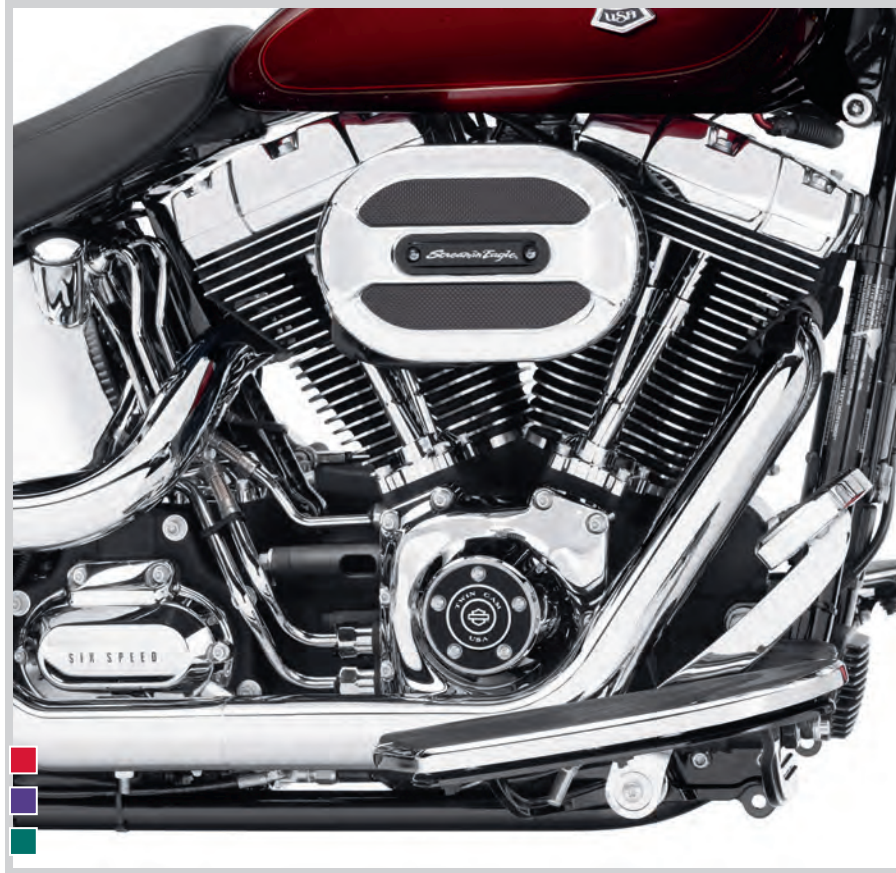

A. TWIN CAM ENGINE COVERS – CHROME



A. TWIN CAM ENGINE COVERS – CHROME



B. INNER PRIMARY COVER TRIM – CHROME (TOURING AND TRIKE SHOWN)



B. INNER PRIMARY COVER TRIM – CHROME



C. CYLINDER BASE COVER – SMOOTH

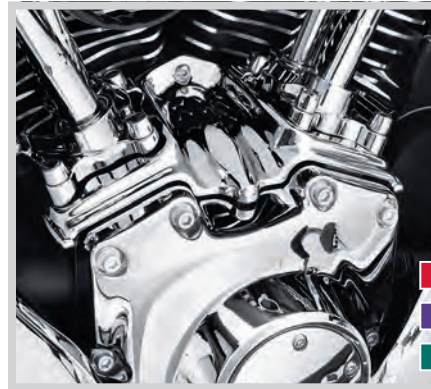

D. TAPPET BLOCK ACCENT



E. GASKET KIT FOR BLACK INNER PRIMARY



E. GASKET KIT FOR BLACK INNER PRIMARY



E. GASKET KIT FOR BLACK INNER PRIMARY

# ENGINE TRIM 447

Engine Covers – Twin Cam

## B. INNER PRIMARY COVER TRIM – CHROME

Get the look of a chrome inner primary cover without tearing apart the drive train. Designed to wrap the top surface of the painted inner primary cover, this mirror chrome die-cast shell provides a beefy finished look to the engine cases. Easy to install, the cover is secured with the outer primary hardware, and held in place at four points for quiet operation. Kit includes required mounting hardware. For a complete custom look, consider adding a Chrome Cylinder Base Cover and Classic Chrome Socket Head Screw Covers (sold separately).

#### 60868-10

Fits '07-'17 Softail® models (except FLSTSC, FXCW, FXCWC, FXSB, FXSBSE and FXSE). Fits with Original Equipment shift linkage and Polished Shift Linkage P/N 33814-98A.

#### 60885-10

Fits '09-'16 Touring and Trike models. Also fits with Chrome Starter Cover P/N 66477-10.

## C. CYLINDER BASE COVER – SMOOTH

Add a finished chrome look to the left side of your Twin Cam engine. This easy-to-install kit includes all necessary mounting hardware.

#### 32042-07

Fits '07-'17 Softail models (except FLSS and FLSTFBS). Will not fit CVO™ models and models equipped with 110-cubic-inch engines.

#### 32077-07

Fits '06-'17 Dyna® (except FXDLS) and '07-'16 Touring and Trike models. Will not fit CVO models and models equipped with 110-cubic-inch engines.

## D. TAPPET BLOCK ACCENT

Shaped to fill the gap between the tappet blocks, this unique cover adds a splash of chrome to the profile of your engine. The die-cast cover is polished and chrome-plated to a mirror finish. Easy to install.

#### 61400002

Fits '99-'17 Twin Cam-equipped models. Does not fit with Lifter Block Covers P/N 18248-99, 18278-06 and 18262-00 or Billet Lifter Cover P/N 18088-02.

## E. GASKET KIT FOR BLACK INNER PRIMARY

It's the details that count. This gasket kit eliminates the silver shadow line you see between the engine and primary. It's the perfect finishing touch any time the primary has been removed for engine service or during the installation of other accessories. Comprehensive kit contains all gaskets and hardware required to reinstall the primary.

#### 25700337

Fits '06-'17 Dyna, '07-'17 Softail, and '07-'16 Touring and Trike models.

Also available:

### EVOLUTION® 1340 ENGINE COVERS – CHROME

#### Inspection Covers – with Shifter Hole

#### 60529-90A

Fits '91-'05 Dyna® models (except FXDWG).

#### Inspection Covers – without Shifter Hole

#### 60572-86

Fits '93-'05 FXDWG and '86-'06 FLST, FXST and FXSTS models.

Model Family Fitment:

- V-ROD
- SPORTSTER
- DYNA
- SOFTAIL
- TOURING



# 448 ENGINE TRIM

Engine Covers – Twin Cam

## A. ENGINE/TRANSMISSION INTERFACE COVER

Featuring a ribbed design for sharp surface contrasts, this chrome Engine/Transmission Interface Cover provides a custom option to conceal the space between the cam cover and the transmission. The cover stretches from the gearcase cover to the rear of the transmission, and frames the transmission side cover with a band of chrome for a complete custom look. Kit includes all necessary mounting hardware.

**66543-08**

Fits '07-'17 Softail® models (except FLSS, FLSTFBS, FLSTNSE, FLSTSC, FXCW, FXCWC, FXSB, FXSBSE and FXSE). Does not fit models equipped with hydraulic clutch.



A. ENGINE/TRANSMISSION INTERFACE COVER

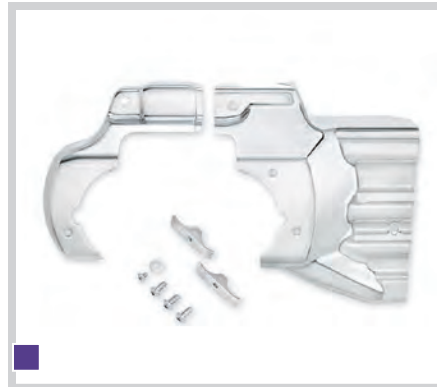

## B. STARTER COVER – CHROME

With the under-chassis exhaust crossover on the late model Touring bikes, the painted starter motor is now easily seen from both sides of the bike. This brilliantly chrome-plated cover conceals the starter motor and starter solenoid for a clean, custom look. Easy to install, this kit includes all required mounting hardware.

**66477-10**

Fits '09-'16 Touring and Trike models (except CVO™ and models with High Output Starter P/N 31621-06A or 31619-06A).



B. STARTER COVER – CHROME



## C. HARLEY-DAVIDSON® GENUINE HIGH PERFORMANCE 1.4KW STARTER

This starter offers both great styling and increased performance, providing 15% greater torque than the stock replacement starter. Engineered and tested by Harley-Davidson from the ground up, this starter offers unparalleled reliability and durability. No special battery or battery cable requirements.

Fits '06-'17 Dyna® (except ABS equipped models) and '07-'17 Softail and '07-'16 Touring and Trike models.

**31619-06A** Black Finish.

**31621-06A** Chrome Finish.

Fits '99-'00 FXR, '94-'05 Dyna and '94-'06 Softail and Touring models.

**31335-03A** Black Finish.

**31559-99A** Chrome Finish.



C. HARLEY-DAVIDSON GENUINE HIGH PERFORMANCE 1.4KW STARTER – CHROME

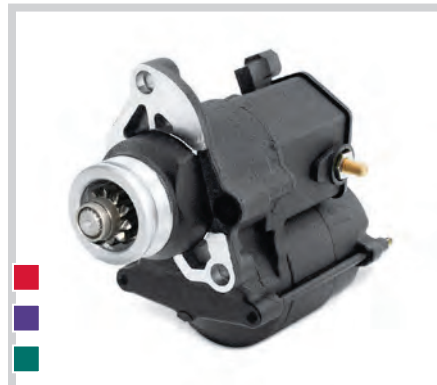

C. HARLEY-DAVIDSON GENUINE HIGH PERFORMANCE 1.4KW STARTER – BLACK

## D. STARTER SOLENOID COVER KIT – CHROME

Add chrome to an often overlooked area with this cover, featuring the same high-quality, bright finish used on most of our accessories.

**31783-00**

Fits '94-later models (except '02-'17 VRSC™, '15-later XG, '18-later Softail and '17-later Touring and Trike models).



D. STARTER SOLENOID COVER KIT – CHROME



E. BILLET FRONT ENGINE MOUNT BRACKET



F. FRONT ENGINE MOUNT COMPONENTS – BLACK



G. PUSHROD COVER KIT – GLOSS BLACK



H. PUSHROD TUBE COLLARS – GLOSS BLACK



I. TAPPET COVERS – BLACK



J. STARTER MOTOR END COVER – GLOSS BLACK (SHOWN WITH SPEED CHECK TRANSMISSION DIPSTICK)

# ENGINE TRIM 449

Engine Covers – Twin Cam

## E. FRONT ENGINE MOUNT COMPONENTS – CHROME

A must-have for any chrome connoisseur, this chrome-plated Front Engine Mount Bracket will set your custom apart from the rest. The chrome bracket is machined from premium 6061-T6 aluminum, and is a direct bolt-on replacement for the Original Equipment bracket. Can be used with the stock stabilizer link, or dressed up with the optional chrome Front Engine Mount Stabilizer Link P/N 16213-10. Kit includes chrome mounting hardware.

**16205-10** Front Engine Mount Bracket.  
Fits '08-'16 Touring models.

Add a custom style to the front end with this brilliant chrome-plated Engine Mount Stabilizer Link. This custom heim joint assembly complements the chrome Billet Front Engine Mount Bracket P/N 16205-10. Kit includes chrome mounting hardware.

**16213-10** Front Tie Link.  
Fits '09-later Touring and Trike models.

## F. FRONT ENGINE MOUNT COMPONENTS – BLACK

Perfect for installation on a blacked-out engine, these black engine mount components replace the factory silver-finished parts and blend these functional items into the background. Manufactured from Original Equipment components for perfect fit and proven reliability.

**16400056** Front Engine Mount Bracket.  
Fits '08-'16 Touring models.

**16400055** Front Tie Link.  
Fits '09-later Touring models.

## G. PUSHROD COVER KIT – GLOSS BLACK

Complete the Dark Custom look. These covers replace existing chrome covers to give your bike a blacked-out appearance down to the smallest detail. Pushrod covers are finished in gloss black and the kit includes the four bottom cover tubes and the four upper clips. Installation retains the Original Equipment chrome short center tube to create a high-contrast accent. Cover Kit can be installed on engines already equipped with Adjustable Pushrods or can be installed by removing rocker box covers, rocker arms and non-adjustable pushrods. Consult your dealer or service manual for installation.

**17900033** Covers Only.  
Fits '99-'17 Twin Cam-equipped models. Requires prior installation of Adjustable Pushrods or removal of rocker box covers, rocker arms and fixed-length pushrods.

## H. PUSHROD TUBE COLLARS – GLOSS BLACK

Manufactured from Original Equipment components for perfect fit and function, these Pushrod Collars complete your Twin Cam engine's conversion to the total blacked-out look. Covers replace the chrome-finished factory covers, and fit with stock or Screamin' Eagle® Quick-Install Pushrods.

**17900076**  
Fits '84-'00 Evolution® 1340 and '99-'17 Twin Cam-equipped models. Installation requires use of Adjustable Pushrods or removal of rocker box covers, rocker arms and fixed-length pushrods.

## I. TAPPET COVERS – BLACK

Complete your Twin Cam engine's conversion to a total blacked-out look. These textured black tappet blocks replace the stock bright-finished components for a sinister appearance, and are manufactured from Original Equipment components for perfect fit and function.

**25700653**  
Fits '99-'17 Twin Cam-equipped models. Sold in pairs.

## J. STARTER MOTOR END COVER – GLOSS BLACK

It's the details that make the complete custom bike. This gloss black round starter end cover replaces the factory-installed chrome cover and is the ideal finishing touch for converting your powertrain to an elegant tuxedo black look. Manufactured from Original Equipment components to ensure a perfect fit, this cover is coated with temperature-resistant finish to ensure a long-lasting finish.

**31400092**  
Fits '08-'16 Touring and Trike models.

Model Family Fitment:

- V-ROD
- SPORTSTER
- DYNA
- SOFTAIL
- TOURING



# 450 ENGINE TRIM

Sportster® Engine & Transmission Trim

## A. RAIL COLLECTION ENGINE COVERS

Tough broad-shouldered attitude with an edge – that’s what you get when you finish your ride with the Rail Collection. We start with factory engineered components to ensure perfect fit and function. Then we apply a rich durable gloss black finish to draw attention to the heart of the bike, and then add machined longitudinal strakes to provide visual length to the powertrain. The resulting look is masculine and aggressive – and it mixes well with either café or urban assault styles. Start with a couple of components, or go all the way.

### 1. Primary Cover

**25700532**

Fits '06-'22 XL models. Includes gloss black Chain Inspection Cover.

### 2. Transmission Sprocket Cover

**34800032**

Fits '04-'22 XL models. Does not fit models equipped with Rear Set Foot Controls P/N 50700040.

NOTE: Removing and installing engine covers may require purchase of new gaskets. See dealer for information.

### Shown with:

#### SCREAMIN' EAGLE® PERFORMANCE AIR CLEANER KIT – RAIL COLLECTION

The look is bold and the performance exhilarating. This race-inspired air cleaner is engineered to flow through the perimeter and the face of the air filter, providing high volumes of unrestricted airflow to the engine. The open-design face plate features a rich black finish with machined longitudinal strakes to expose the glowing aluminum below. Kit includes air cleaner trim, one-piece cast back plate, high-flow washable air filter element, rain sock and all required hardware. 50-State U.S. EPA compliant.

**29400232A**

Fits '07-'22 XL models with Original Equipment throttle body. All models require ECM calibration for proper installation. '17-later models require recalibration with Screamin' Eagle® Pro Street Tuner (sold separately). Pending approval for use in California on '21 models. Refer to H-D.com/shop for status.



A. RAIL COLLECTION ENGINE COVERS

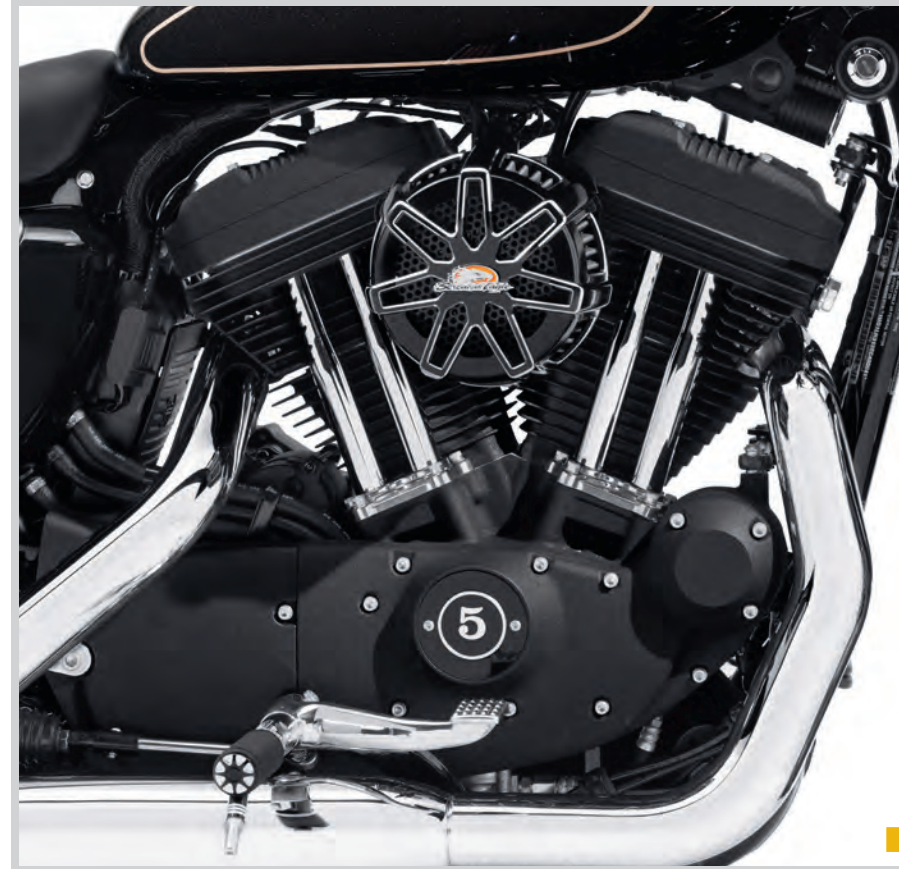

B. WRINKLE BLACK ENGINE COVERS

# ENGINE TRIM 451

Sportster® Engine & Transmission Trim

## B. WRINKLE BLACK ENGINE COVERS

These black powder-coated engine covers are the perfect start in converting your powertrain to a striking wrinkle black look. Manufactured from Original Equipment components, these covers are masked and painted on the factory production paint line to ensure a matching wrinkle black or texture black finish and a perfect fit. Complete the blacked-out look with matching primary covers, rocker housings, rocker covers, cam covers and transmission covers (sold separately).

### 1. Gearcase Cover

**25486-05** Fits '04-'22 XL models.

### 2. Transmission Sprocket Cover

**34943-05** Fits '04-'22 XL models.

### 3. Rocker Box Lower Housing (each)

**17645-07A** Fits '07-'22 XL models.

### 4. Rocker Box Cover (each)

**17655-05** Fits '04-'22 XL models.

### 5. Primary Cover

**25307-06** Fits '06-'22 XL models.

### 6. Primary Chain Inspection Cover

**34794-05A** Fits '04-'22 XL models.

### 7. Derby Cover

**34790-05** Fits '04-'22 XL models.

NOTE: Removing and installing engine covers may require purchase of new gaskets. See dealer for information.

### Shown with:

#### SCREAMIN' EAGLE® EXTREME BILLET AIR CLEANER KIT – CHISEL

The bold styling of this intake system looks just as impressive as the long patch of burnout rubber you just laid down. The forged billet aluminum cover tops off a cast back plate with integral breather for a smooth transition to the throttle body. The race-inspired air cleaner is engineered to flow high volumes of air and the washable pleated element provides the ideal combination of efficiency and engine protection. Available in your choice of style and finish, this easy-to-install kit includes all mounting hardware and rain sock. 50-State U.S. EPA compliant.

**29400127** Cut Back Gloss Black.

Fits '07-'22 XL models with Original Equipment throttle body. All EFI models require ECM calibration for proper installation. '17-later models require recalibration with Screamin' Eagle® Pro Street Tuner (sold separately). Labor cost not included. See Dealer for details.



A. RAIL COLLECTION ENGINE COVERS



B. WRINKLE BLACK ENGINE COVERS



**GO LIGHT** These Screamin' Eagle products are 50-state street compliant for sale and use on all vehicles, including those that are pollution-controlled. Complies with the requirements of 40 CFR Part 86, subparts E and F. Street legal and/or street compliant statements refer to product meeting 50-state emissions and noise standards in the United States.



**GO LIGHT** These Screamin' Eagle products are 50-state street compliant for sale and use on all vehicles, including those that are pollution-controlled. Complies with the requirements of 40 CFR Part 86, subparts E and F. Street legal and/or street compliant statements refer to product meeting 50-state emissions and noise standards in the United States.

### Model Family Fitment:

- V-ROD
- SPORTSTER
- DYNA
- SOFTAIL
- TOURING



# 452 ENGINE TRIM

Sportster® Engine & Transmission Trim

## A. CHROME ENGINE COVERS

Dress the engine of your Sportster® model in chrome. These polished and chrome-plated components are manufactured to Original Equipment specifications for exact fit and finish.

### 1. Primary Cover

**25460-06** Fits '06-'22 XL models.

**25460-04** Fits '04-'05 XL models.

### 2. Gearcase Cover

**25213-04** Fits '04-'22 XL models.

### 3. Transmission Sprocket Cover

**34932-04** Fits '04-'22 XL models.

### 4. Rocker Box Lower Housing (each)

**17537-07A** Fits '07-'22 XL models.

**17537-96C** Fits '86-'06 XL models.

### 5. Rocker Box Cover (each)

**17551-04** Fits '04-'22 XL models.

### 6. Primary Chain Inspection Cover

**34761-04A** Fits '04-'22 XL models.

### 7. Derby Cover

**34760-04** Fits '04-'22 XL models.

### Also available:

#### CHROME ENGINE KIT – SPORTSTER®

Upgrade your motor with brilliant chrome components. Kit includes chrome gear cover, transmission sprocket cover, primary chain inspection cover, derby cover, inner and outer rocker covers and all gaskets.

#### 16295-07A

Fits '07-'22 XL models. Stock on '07-'22 XL1200C, XL1200L, XL1200T, XL1200V and XL 50th Anniversary models.

### Shown with:

#### SMOOTH AIR CLEANER COVER

Wrap your Screamin' Eagle® round air cleaner element in style. The mirror chrome low-profile Air Cleaner Cover shields the element and opens breathing space between the backing plate and the cover. Cut-away bottom design exposes the air cleaner element to maximize the airflow. Easy to install, the one-piece cover is the ideal complement to the Chrome Air Cleaner Back Plate P/N 29510-05.

#### 29153-07

Fits '07-'22 XL models equipped with Screamin' Eagle Round High-Flow Air Cleaner Kits and '99-'17 Twin Cam models equipped with Screamin' Eagle Round High-Flow Air Cleaner Kits.



A. CHROME ENGINE COVERS



A. CHROME ENGINE COVERS



B. PUSHROD COVER KIT – GLOSS BLACK

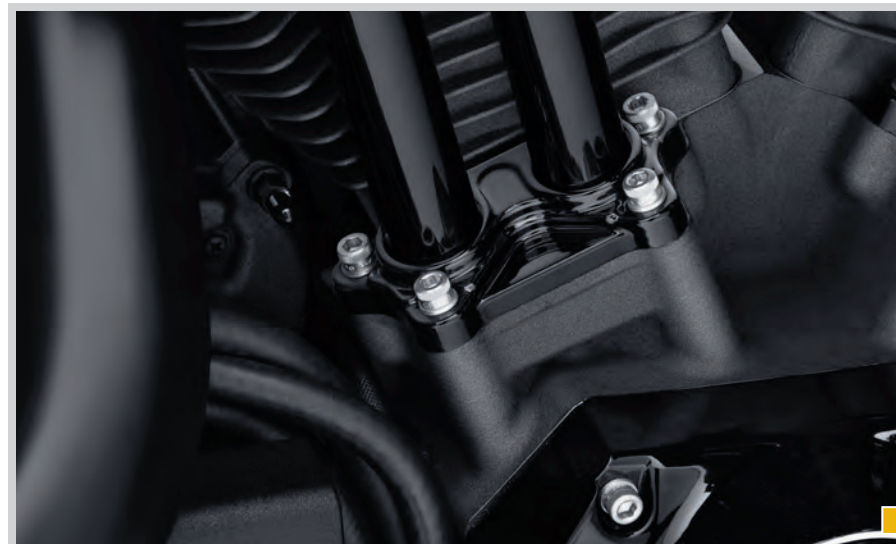

C. TAPPET COVERS – GLOSS BLACK



D. FRONT ENGINE MOUNT STABILIZER LINK

# ENGINE TRIM 453

Sportster® Engine Trim

## B. PUSHROD COVER KIT – GLOSS BLACK

These Pushrod Covers add to your bike's blacked-out look and are coated with durable, heat-resistant gloss black paint. The kit includes four bottom cover tubes and four upper clips. Pushrod Covers are a great add-on when upgrading the top end of your engine with Screamin' Eagle® performance cylinder heads.

#### 17900083

Fits '04-'22 XL and XR models. Includes 4 Pushrod covers. Requires removal of cylinder heads for installation.

## C. TAPPET COVERS – GLOSS BLACK

Complete your Sportster® engine's conversion to a total blacked-out look. These Tappet Covers replace the bright-finished stock covers and are manufactured from Original Equipment components with heat-resistant gloss black paint for perfect fit and function.

#### 17900084

Fits '04-'22 XL and XR models. Includes 2 covers and 2 gaskets. Requires removal of cylinder heads for installation.

## D. FRONT ENGINE MOUNT STABILIZER LINK

Add a custom style to the front end with this brilliant chrome-plated Engine Mount Stabilizer Link. This custom heim joint assembly is designed to link the engine to the engine mount bracket and can be used to replace the Original Equipment upper or lower front tie link. For a complete transformation, install two Stabilizer Links and the complementing chrome Billet Front Engine Mount Bracket P/N 16400022. Kit includes one stabilizer link and chrome mounting hardware.

#### 16400020

Fits '04-'22 XL and '08-'13 XR models.

### Model Family Fitment:

- V-ROD
- SPORTSTER
- DYNA
- SOFTAIL
- TOURING



## 454 ENGINE TRIM

### Air Cleaner Covers

#### A. 120TH ANNIVERSARY AIR CLEANER TRIM – STANDARD

Celebrate 120 years of Harley-Davidson pride and craftsmanship. This easy-to-install accessory trim is also standard equipment on the limited-edition Harley-Davidson® 120th Anniversary models. Handsome red fade finish with subtle gold and black accents.

##### 61301326

Fits '17-later Touring and Trike models with Original Equipment wedge shaped air cleaner cover. Does not fit CVO™ models.



A. 120TH ANNIVERSARY AIR CLEANER TRIM – STANDARD

#### B. 120TH ANNIVERSARY AIR CLEANER TRIM – VENTILATOR

Celebrate 120 years of Harley-Davidson pride and craftsmanship. This easy-to-install accessory trim is also standard equipment on the limited-edition Harley-Davidson® 120th Anniversary models. Handsome red fade finish with subtle gold and black accents.

##### 61301327

Fits '18-later Softail® and '17-later Touring and Trike models equipped with Ventilator Air Cleaner P/N 29400298 or 29400299. Also fits '18-later Softail® models with 114CI engines and '17-later CVO™ touring models with Original Equipment Ventilator Air Cleaner with separate purchase of Air Filter P/N 29400293.



B. 120TH ANNIVERSARY AIR CLEANER TRIM – VENTILATOR

#### C. AIR CLEANER TRIM – BRUSHED ALUMINUM

Show off your Milwaukee-Eight® engine's displacement with pride. Available for 107- and 114-cubic-inch engines, this brushed aluminum and black trim is the perfect complement to chrome or black engine finishes. This easy-to-install self-adhesive formed aluminum trim fits perfectly into the recessed face of the Softail models Original Equipment perimeter bolt air cleaner cover.

##### 61300788

107 Logo.  
Fits '18-later FLFB, FLFSB, FXBB, FXBR and FXFB models with Original Equipment perimeter bolt air cleaner cover.



C. AIR CLEANER TRIM – BRUSHED ALUMINUM

#### D. AIR CLEANER COVER – GLOSS BLACK

Complete the blacked-out look. Original Equipment on the FLSS model, this Gloss Black Air Cleaner Cover adds a sinister touch without changing the signature profile of your late model Twin Cam motor.

##### 61300536

Fits '16-'17 Softail (except FLSTFBS) and '14-'16 Touring and Trike models (except CVO™) with Original Equipment Air Cleaner or models equipped with Screamin' Eagle Round High-Flow Air Cleaner P/N 29400233 or 29400234.



D. AIR CLEANER COVER – GLOSS BLACK

#### E. SCREAMIN' EAGLE® VENTILATOR ELITE AIR CLEANER COVER

Add a luxurious finishing touch to your Ventilator Air Cleaner. Designed as a direct replacement for the Screamin' Eagle® and CVO™ Ventilator Air Cleaners, this easy-to-install cover features a sleek center bar design surrounded with carbon fiber inserts. Kit includes low-profile cover, diamond-cut Screamin' Eagle medallion and chrome mounting hardware.

Fits '10-'17 Dyna®, '09-'16 Softail®, '09-'16 Touring and Trike models equipped with Ventilator Air Cleaner Kits. Also fits Dyna HO103 and CVO™ models with Original Equipment Ventilator Air Cleaner.

##### 61300516

Chrome.

##### 61300517

Gloss Black.



E. SCREAMIN' EAGLE VENTILATOR ELITE AIR CLEANER COVER – CHROME



E. SCREAMIN' EAGLE VENTILATOR ELITE AIR CLEANER COVER – GLOSS BLACK



F. MILWAUKEE-EIGHT ENGINE AIR CLEANER COVER – GLOSS BLACK



G. NOSTALGIC BAR & SHIELD LOGO AIR CLEANER COVER – ROUND



H. SMOOTH AIR CLEANER COVER



I. BOBBER-STYLE ROUND AIR CLEANER COVER – CHROME



I. BOBBER-STYLE ROUND AIR CLEANER COVER – GLOSS BLACK

## ENGINE TRIM 455

### Air Cleaner Covers

#### F. MILWAUKEE-EIGHT® ENGINE AIR CLEANER COVER – GLOSS BLACK

Complete the blacked-out look. This Gloss Black Air Cleaner Cover adds a sinister touch without changing the signature profile of your Milwaukee-Eight® engine.

##### 61300828

Fits '17-later Touring (except CVO™) and Trike models with Original Equipment air cleaner or Screamin' Eagle® Wedge High-Flow Air Cleaner.

#### G. NOSTALGIC BAR & SHIELD LOGO AIR CLEANER COVER

Get a polished look with an extra dose of heritage with the Nostalgic Collection – chrome-plated air cleaner covers featuring an original-style Bar & Shield logo and a stamped "Made in U.S.A." An easy-to-install trip down memory lane, each cover is hand-polished and chrome-plated to a brilliant finish. Available in oval and round configurations, the air cleaner kit includes polished stainless steel mounting hardware.

##### 29138-91A

Round.  
Fits '90-'99 carbureted (CV) Evolution® 1340-equipped models. Also fits '07-'22 XL and '99-'17 Twin Cam models equipped with Screamin' Eagle High-Flow Air Cleaners (round filter) when installed with Gasket Kit P/N 29591-99 (sold separately).

#### H. SMOOTH AIR CLEANER COVER

Wrap your Screamin' Eagle round air cleaner element in style. The mirror chrome low-profile Air Cleaner Cover shields the element and opens breathing space between the backing plate and the cover. Cut-away bottom design exposes the air cleaner element to maximize the airflow. Easy to install, the one-piece cover is the ideal complement to the Chrome Air Cleaner Back Plate P/N 29510-05.

##### 29153-07

Fits '07-'22 XL models equipped with Screamin' Eagle Round Filter Air Cleaner Kits and '99-'17 Twin Cam models equipped with Screamin' Eagle Round High-Flow Air Cleaner Kits.

#### I. BOBBER-STYLE ROUND AIR CLEANER COVER

Low-profile round air cleaner cover adds an attractive nostalgic look to any bike's profile. The cover features a cut-away bottom design that exposes the filter element to maximize the airflow when installed with a Screamin' Eagle High-Flow Air Cleaner Kit.

Fits '12-'16 XL1200V and '11-'15 FLS and FXS models with Original Equipment round air cleaner. Also fits models equipped with Screamin' Eagle Round High-Flow Air Cleaner Kits.

##### 61300120

Chrome.

##### 61300128

Gloss Black.

#### Model Family Fitment:

 V-ROD	 SPORTSTER	 DYNA
 SOFTAIL	 TOURING	



# 456 ENGINE TRIM

Oil Temp & Level

## A. OIL LEVEL AND TEMPERATURE DIPSTICK WITH LIGHTED LCD READOUT

New and improved capacitive level sensing technology provides the highest degree of accuracy and durability. Now available in chrome and black, these dipsticks allow you to check your oil level and oil temperature with the push of a button. Add function and style by replacing your stock dipstick with this hard-working version. No more grabbing a rag to pull your hot dipstick. No more oil drips on your pipes and on the garage floor. Simply push the button and this dipstick lights up with a brilliant backlight. Oil level is indicated by a four-segment readout—it even reminds you to check your oil when it is hot. Designed to be waterproof, the LCD (liquid crystal display) readout operates on a long-lasting, replaceable lithium coin-type battery (CR2032 3V, P/N 91800066). Display features a low battery indicator and press-and-hold feature to toggle between Fahrenheit and Celsius.

Fits '04-'22 XL and XR models.

**62700009** Chrome.

**62700011** Gloss Black.

Fits '06-'17 Dyna® models (except FLD).

**63065-09A** Gloss Black.

Fits '00-'17 Softail® models (except FXCW, FXCWC, FXSB, FXSBSE, FXSE and '09 FXSTSSE).

**62955-09A** Chrome.

**63055-09A** Gloss Black.

Fits '08-'17 FXCW, FXCWC, FXSB, FXSBSE, FXSE and '09 FXSTSSE models.

**63002-09A** Chrome.

Fits '17-later Touring models.

**62700180** Chrome.

**62700194** Gloss Black.

Fits '07-'16 Touring models (except models equipped with a Sidecar). Will not fit Touring models equipped with Engine/Transmission Interface Cover P/N 66532-07.

**63004-09A** Chrome.

**63030-09A** Gloss Black.

Fits '02-'06 Touring models (except models equipped with a Sidecar). Also fits '99-'01 Touring models equipped with Chrome Oil Filler Spout P/N 62470-02, 62453-02 or 62454-02A.

**62946-09A** Chrome.

**63131-09A** Gloss Black.

Fits '09-'16 Trike models. Also fits '09-'16 Touring models equipped with a sidecar.

**62700005A** Chrome.

**Also available:**

**LCD DIPSTICK BATTERY AND SEAL KIT**

Kit includes CR2032 3V Lithium Replacement Battery and waterproof seal kit.

**91800066**



**A. OIL LEVEL AND TEMPERATURE DIPSTICK – CHROME (DYNA SHOWN)**



**A. OIL LEVEL AND TEMPERATURE DIPSTICK – BLACK (DYNA SHOWN)**



**A. OIL LEVEL AND TEMPERATURE DIPSTICK – CHROME (SPORTSTER SHOWN)**



**A. OIL LEVEL AND TEMPERATURE DIPSTICK – BLACK (SOFTAIL SHOWN)**

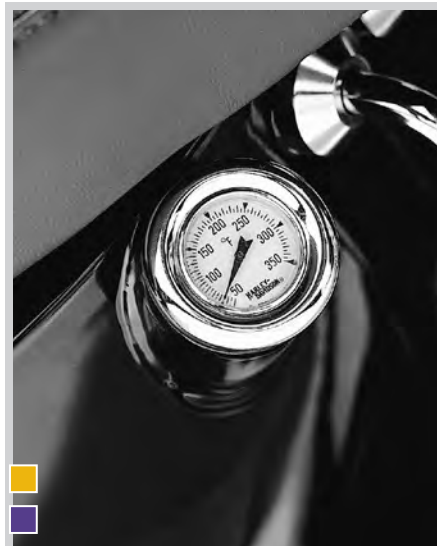

**B. OIL DIPSTICK WITH TEMPERATURE GAUGE (SOFTAIL SHOWN)**



**B. OIL DIPSTICK WITH TEMPERATURE GAUGE ('04-LATER SPORTSTER SHOWN)**

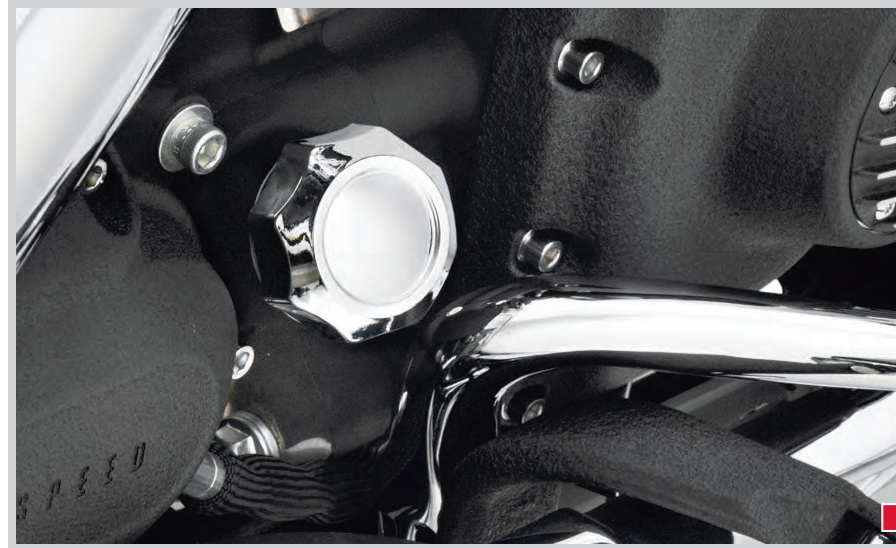

**C. CHROME OIL DIPSTICK – '06-LATER DYNA**



**D. FUEL TANK FITTING COVER**



**E. BRAIDED STAINLESS STEEL EFI FUEL LINE**



**F. BRAIDED STAINLESS STEEL FUEL CROSSOVER LINE**

# ENGINE TRIM 457

Oil Level Dipsticks & Fuel Lines

## C. CHROME OIL DIPSTICK

Easy-to-install chrome-plated oil dipstick adds a finishing touch and shows your attention to detail.

**62858-99** Fits '99-'06 Touring models.

## D. FUEL TANK FITTING COVER

This classic chrome styled two-piece die-cast cover conceals the EFI fuel line fitting below the tank. Easy to install, the kit includes chrome-plated hardware and hex key wrench.

**62809-06**

Fits '04-'07 fuel injected Dyna®, '02-'17 fuel injected Softail® and '03-'16 fuel injected Touring and Trike models.

## E. BRAIDED STAINLESS STEEL EFI FUEL LINE

Add a finishing touch to the fuel-injected Dyna with this Braided Stainless Steel Fuel Line. Complete replacement line includes pre-installed fuel tank and EFI module connectors.

**63020-04**

Fits '04-'05 EFI Dyna models.

## F. BRAIDED STAINLESS STEEL FUEL CROSSOVER LINE

A beautifully Braided Stainless Steel Fuel Line accented with highly polished chrome fittings for your front fuel tank crossover. Innovative fittings are designed to eliminate unsightly hose clamps.

**63698-02** Fits '97-'07 Touring models.

**63692-00A**

Fits '00-'17 Softail models (except FXCW, FXCWC and FXSTD).

Model Family Fitment:

V-ROD   
  SPORTSTER   
  DYNA  
 SOFTAIL   
  TOURING



# 458 ENGINE TRIM

Cylinder Head Covers

## A. FINNED HEADBOLT BRIDGE

This exclusive aluminum Finned Headbolt Bridge covers both headbolts and the spark plug, filling out your cylinder fins all the way to the rocker box. Featuring an engraved Bar & Shield emblem, the bridge is easy to install with unique headbolt mounts. All necessary mounting hardware included. Sold in pairs.

**43859-00** Black Highlighted.  
Fits '99-'17 Twin Cam-equipped models with electronic fuel injection and '00-later FXSTD models.

**61400148** CVO™ Granite Highlighted.  
Fits '99-'17 Twin Cam-equipped models with electronic fuel injection and '00-later FXSTD models.

**61400176** Solid Black.  
Fits '04-'22 XL models.



A. FINNED HEADBOLT BRIDGE – BLACK HIGHLIGHTED



A. FINNED HEADBOLT BRIDGE – CVO GRANITE HIGHLIGHTED

## B. HEADBOLT BRIDGE – CHROME

This exclusive Headbolt Bridge covers both the headbolts and spark plug with a splash of chrome and an engraved Bar & Shield emblem. Easy to install with unique headbolt mounts. Kit includes all necessary mounting hardware. Sold in pairs.

**43858-00**  
Fits '99-'17 Twin Cam-equipped models. (Will not fit with Screamin' Eagle® heads or 110Cl or 117Cl engines.)

**44432-04**  
Fits '04-'22 XL and XR models.



A. FINNED HEADBOLT BRIDGE – SOLID BLACK

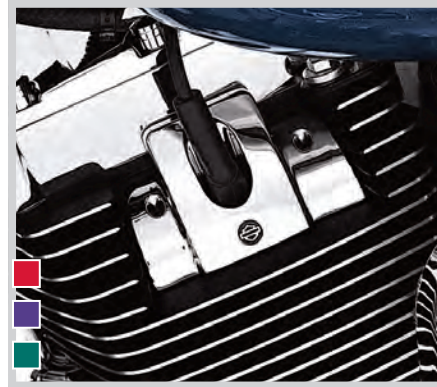

B. HEADBOLT BRIDGE – CHROME

## C. SPARK PLUG COVER KITS

Quickly slips over spark plug for a secure fit.

**32747-99** Classic Chrome.  
Fits '99-'17 Twin Cam-equipped models.

**32745-99** H-D Motor Co. Logo.  
Fits '99-'17 Twin Cam-equipped models.

## D. HEADBOLT COVERS

Precision-machined of high-quality aluminum and manufactured in the U.S.A. Hand-polished and chrome-plated. Available in a variety of styles to match your customizing direction, these kits include 4 easy-to-install headbolt covers, set screws and an Allen® wrench for easy installation.

Fits '86-'22 XL, '08-'13 XR, '85-'99 Evolution® 1340 and '99-'17 Twin Cam models.

- 43822-01** Chrome.
- 43896-99** Gloss Black.
- 43911-95** Chrome Bar & Shield Logo.
- 43884-96** Chrome H-D Motor Co. Logo.



C. SPARK PLUG COVERS (32745-99 SHOWN)



C. SPARK PLUG COVERS (32745-99 SHOWN)

## E. CLASSIC CHROME ROCKER BOX BOLT COVERS

Matching the styling of our classic chrome headbolt covers, these chrome-plated Rocker Box Bolt Covers add chrome to your engine. Easy to install, the covers are held in place by a spring steel clip. Sold in packages of four.

**43868-99**  
Fits '99-'17 Twin Cam-equipped models.



D. HEADBOLT COVERS



E. CLASSIC CHROME ROCKER BOX BOLT COVERS

- Model Family Fitment:
- V-ROD
  - SPORTSTER
  - DYNA
  - SOFTAIL
  - TOURING

# ENGINE TRIM 459

Docking Hardware Covers

## F. REAR DOCKING HARDWARE COVER KIT

Disguise the rear docking hardware with these easy-to-install covers. The caps slide over the exposed docking points, and are held in place by a strong magnetic pull. The caps are easy to remove when you wish to reinstall detachable accessories. Covers are available with brilliant chrome or durable gloss black finish to match your bike's attitude. Sold in pairs.

Fits many accessory docking hardware kits. Refer to the fitment matrix below or the Parts & Accessories section of [www.harley-davidson.com](http://www.harley-davidson.com) for details.

**48218-10** Short Chrome (pair).

**48220-10** Large Chrome (pair).

**48035-09** Small Chrome (pair).

**48221-10** Short Black (pair).

**48223-10** Large Black (pair).

**48225-10** Small Black (pair).



F. REAR DOCKING HARDWARE COVER KIT – CHROME



F. REAR DOCKING HARDWARE COVER KIT – BLACK



Docking Kit Part Number	Fitment	Large Chrome: 48220-10 Black: 48223-10	Small Chrome: 48035-09 Black: 48225-10	Short Chrome: 48218-10 Black: 48221-10
<b>XL Models</b>				
53529-04	Fits '04-'22 XL (some black) models.	—	1	1
53532-02	Fits '02-'03 XL (with bags) models.	1	—	—
90465-98A	Fits '94-'01 XL (with bags) models.	1	—	—
<b>Dyna® Models</b>				
53961-06	Fits '06-'17 Dyna® (FXD/L) models.	—	1	1
53964-06B	Fits '08-'17 FXDF, '09-'10 FXDFSE and '06-'08 FXDWG models.	—	1	1
54097-10	Fits '10-'17 FXDWG (black) models.	—	1	1
53797-09	Fits '09-'17 FXDB (black) models.	—	1	1
53858-01	Fits '96-'01 FXDWG (except FXDWG2) models.	1	—	—
<b>Softail® Models</b>				
53932-03A	Fits '03-'17 Softail® (without bags) models.	1	1	—
<b>Touring Models</b>				
52300131	Fits '14-later Touring (4pt) chrome models.	—	2	—
52300353	Fits '14-later Touring (4pt) chrome models.	—	2	—
52300354	Fits '14-later Touring (4pt) black models.	—	2	—
54205-09	Fits '09-'13 Touring (4pt) chrome models.	—	2	—
54246-09	Fits '09-'13 Touring (4pt) black models.	—	2	—
54030-09	Fits '09-'13 Touring (2pt) chrome models.	—	1	—
54249-09	Fits '09-'13 Touring (2pt) black models.	—	1	—
53803-06	Fits '97-'08 Touring (front) models.	—	1	—
53804-06	Fits '94-'08 Touring (rear) models.	1	1	—
53988-07	Fits '07-'08 FLHRSE3/4 models.	—	1	1



# 460 ENGINE TRIM

Hardware Covers

## A. CLASSIC COVERS KIT

Customize your bike down to the last detail. These hardware Cover Kits include the chrome-plated ABS caps and plugs in the sizes and styles required to dress the viewable hardware on the motorcycle. Classic Covers are available as complete Bike Kits with the covers for both engine and chassis hardware, or as engine-only kits to dress the Twin Cam or XL engine. The kits are easy to install, with no tools required.

**94923-09** Bike Kit.  
Fits '09-'17 Softail® models (except FLS, FLSS, FLSTSB, FXCW, FXCWC and FXSE).

**94924-09** Bike Kit.  
Fits '09-'13 Touring and Trike models.

**94943-07** Engine Kit.  
Fits Twin Cam-equipped models.

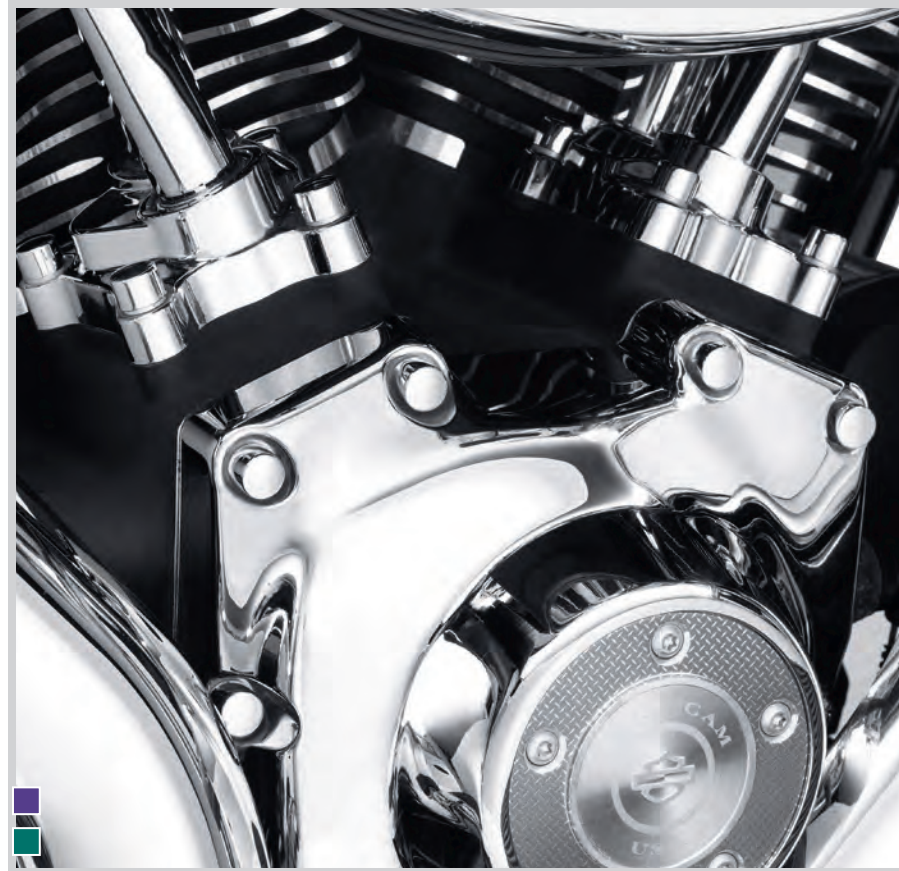

A. CLASSIC COVERS KIT

## Typical Classic Covers Kit Contents

Intended Fastener	Part Number	Bike Kit	Bike Kit	Engine Kit
		'09-'17 Softail	'09-'16 Touring	Twin Cam models
		<b>94923-09</b>	<b>94924-09</b>	<b>94943-07</b>
1/4" socket head cap screw	<b>94903-07</b>	50	55	50
5/16" socket head cap screw	<b>94904-07</b>	11	8	7
5/16" socket head cap screw (plug)	<b>94905-07</b>	4	—	—
3/8" socket head cap screw	<b>94906-07</b>	6	3	3
5/16" special hex screw (angled cap)	<b>94907-07</b>	8	8	8
5/16" T40 Torx® button head screw	<b>94908-07</b>	5	10	—
3/8" T45 Torx button head screw	<b>94909-07</b>	5	—	—
1/4" 12-point screw	<b>94910-07</b>	—	—	—
10mm 12-point screw	<b>94911-07</b>	5	4	—
1/2" flanged hex bolt	<b>94912-07</b>	1	2	—
3/8" T45 Torx button head screw	<b>94913-07</b>	10	2	—
7/16" hex bolt	<b>94914-07</b>	5	—	—
3/8" hex bolt (9/16" hex)	<b>94915-07</b>	1	—	3
3/8" deep hex bolt (9/16" hex)	<b>94916-07</b>	—	—	—
1/4" hex bolt (7/16" hex)	<b>94917-07</b>	—	14	—
5/16" hex bolt (1/2" hex)	<b>94918-07</b>	4	10	8
1/2" hex bolt	<b>94919-07</b>	4	—	—
1/2" deep hex bolt	<b>94920-07</b>	1	—	—
7/16" hex bolt	<b>94941-07</b>	—	—	—
5/16" T40 Torx button head screw	<b>94942-07</b>	4	—	—



B. CHROME SOCKET HEAD SCREW COVER KIT



## B. CHROME SOCKET HEAD SCREW COVER KIT

Finish the show-winning look with these easy-to-install hardware covers. These machined brass and chrome-plated covers are corrosion resistant, and the internal spring steel retention clip resists vibration and thermal cycling to securely hold the covers in place.

**94830-02**  
Fits 1/4" socket head screws with hex drive (pkg. of 10).

**94832-02**  
Fits 5/16" socket head screws with hex drive (pkg. of 4).

## C. CHROME ALLEN® HOLE PLUGS

**94130-93T** 1/4" (pkg. of 10).

**94131-93T** 5/16" (pkg. of 10).

**94132-93T** 3/8" (pkg. of 10).

## D. CHROME HEX BOLT COVERS

Place over a variety of exposed bolts for a cleaner, detailed look. Compression clips for a secure fit. Sold in packages of 6 covers with retaining clips.

**43881-96** Fits 1/2" hex bolts.

## E. CHROME AIR CLEANER SCREW

Complete the chrome on your stock air cleaner cover with this chrome-plated stainless steel screw, which easily replaces the polished stock air cleaner screw.

**29703-00** Fits stock Evolution® 1340 engines.

## F. CHROME TIMER COVER SCREW KITS

Dress up accessory timer covers by replacing the stock zinc plate screws with brilliant chrome.

**32690-99A** Fits Twin Cam 5-hole timer covers. Kit contains five chrome-plated button head Torx® screws.

**94208-04**  
Fits '04-'22 XL, '18-later Softail® and '17-later Touring models.

## G. CHROME DERBY COVER SCREW KIT

Dress up accessory derby covers by replacing the stock zinc-plated screws with brilliant chrome.

**25913-99**  
Fits '99-later Dyna®, Softail, Touring and Trike models. Kit contains five chrome-plated button head Torx screws and five stainless steel washers.

**94630-98** Fits Evolution 1340 models. Kit includes three button head Torx screws and oil seals.

**94631-98** Fits '94-'03 XL models.

**94207-04** Fits '04-'22 XL models.



C. CHROME ALLEN HOLE PLUGS



D. CHROME HEX BOLT COVERS



E. CHROME AIR CLEANER SCREW



F. CHROME TIMER COVER SCREW KIT – TWIN CAM SHOWN



G. CHROME DERBY COVER SCREW KIT – TWIN CAM SHOWN

## Model Family Fitment:

- V-ROD
- SPORTSTER
- DYNA
- SOFTAIL
- TOURING



# 462 ENGINE TRIM

Black Hardware Kits

## A. BLACK HARDWARE KITS – ENGINE

Durable and easy to install, this gloss-black engine hardware adds a custom touch to the blacked-out look of your motorcycle. Kits include the hardware required to replace all of the visible zinc-plated fasteners on the vehicle's engine, primary, rocker boxes, derby or cam covers. Lock patch included where required.

### BLACK HARDWARE KIT – FULL ENGINE

Includes the hardware required to replace the visible set of zinc-plated fasteners on the primary cover, derby cover, transmission side and top covers, tappet covers, cam covers and rocker box covers.

**12600251**

Fits '17-later Touring and Trike models.

**12600256**

Fits '18-later Softail® models. '18 models (except FLSB) require additional purchase of Derby Cover Kit P/N 12600255.

### BLACK HARDWARE KIT – PRIMARY COVER

**12600252**

Fits '17-later Touring and Trike models.

**12600257**

Fits '18-later Softail models.

### BLACK HARDWARE KIT – TRANSMISSION

**12600253**

Fits '18-later Softail and '17-later Touring and Trike models.

### BLACK HARDWARE KIT – ROCKER BOX

**12600254**

Fits '18-later Softail and '17-later Touring and Trike models.

**12600263**

Fits '04-'22 XL models.

### BLACK HARDWARE KIT – CAM COVER AND TAPPET COVERS

**12600258**

Fits '18-later Softail and '17-later Touring and Trike models.

### BLACK HARDWARE KIT – DERBY COVER

**12600259**

Fits '19-later Softail and '18-later FLSB models.

**12600255**

Fits '06-'17 Dyna®, '08-'18 Softail (except FLSB) and '08-later Touring and Trike models.

Also available (not shown)

### BLACK HARDWARE KIT – DERBY AND PRIMARY COVER

**12600261**

Fits '04-'22 XL models.



A. BLACK HARDWARE KITS – FULL ENGINE (12600251 SHOWN)



A. BLACK HARDWARE KIT – FULL ENGINE (12600251 SHOWN)



A. BLACK HARDWARE KIT – PRIMARY COVER (12600252 SHOWN)



A. BLACK HARDWARE KIT – TRANSMISSION (12600253 SHOWN)



A. BLACK HARDWARE KIT – ROCKER BOX (12600254 SHOWN)

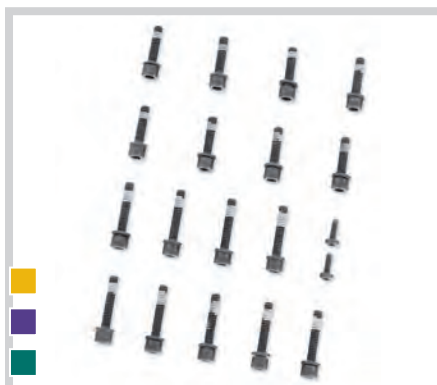

A. BLACK HARDWARE KIT – CAM COVER AND TAPPET COVERS (12600258 SHOWN)



A. BLACK HARDWARE KIT – DERBY COVER (12600255 SHOWN)



B. CHROME HARDWARE KIT – PRIMARY COVER

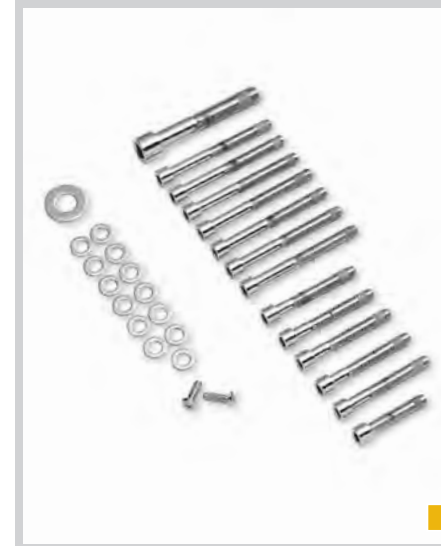

C. CHROME HARDWARE KIT – GEARCASE/FRONT SPROCKET COVER



D. CHROME HARDWARE KIT – TRANSMISSION (SOFTAIL SHOWN)

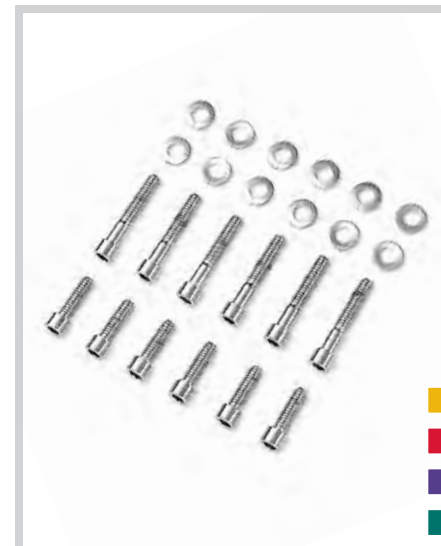

E. CHROME HARDWARE KIT – ROCKER BOX (BIG TWIN SHOWN)

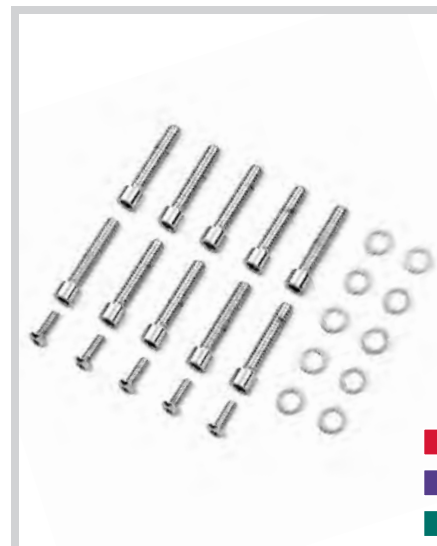

F. CHROME HARDWARE KIT – CAM COVER



G. CHROME HARDWARE KIT – LIFTER/TAPPET BLOCK

# ENGINE TRIM 463

Chrome Hardware Kits

## B. CHROME HARDWARE KIT – PRIMARY COVER

Kit includes the hardware required to replace the visible set of zinc-plated fasteners on the outer primary cover. Inspection and derby cover hardware included. Lock patch included where required.

**94281-04** Fits '04-'22 XL models.

## C. CHROME HARDWARE KIT – GEARCASE/FRONT SPROCKET COVER

Kit includes the hardware required to replace the visible set of zinc-plated fasteners on the gearcase and front sprocket cover. Lock patch included where required.

**94280-04** Fits '04-'22 XL models.

## D. CHROME HARDWARE KIT – TRANSMISSION

Kit includes the hardware required to replace the visible set of zinc-plated fasteners on the transmission top cover, bearing housing assembly and clutch release cover. Lock patch included where required.

**94056-03** Fits '99-'05 Dyna® models.

**94055-03** Fits '00-'06 Softail® models.

**34856-06A**

Fits '06-'17 Dyna and '07-'17 Softail and Touring models.

## E. CHROME HARDWARE KIT – ROCKER BOX

Kit includes the hardware required to replace the visible set of zinc-plated fasteners on rocker box covers. Lock patch included where required.

**94291-04A** Fits '04-'22 XL models.

**94059-03**

Fits '99-'17 Dyna, '00-'17 Softail, and '99-'16 Touring and Trike models.

## F. CHROME HARDWARE KIT – CAM COVER

Kit includes the hardware required to replace the visible set of zinc-plated fasteners on the cam cover. Cam position sensor cover hardware included. Lock patch included where required.

**94058-03**

Fits '99-'17 Dyna, '00-'17 Softail, and '99-'16 Touring and Trike models.

## G. CHROME HARDWARE KIT – LIFTER/TAPPET BLOCK

Kit includes the hardware required to replace the visible set of zinc-plated fasteners on lifter block covers. Lock patch included where required.

**94068-03**

Fits '99-'17 Dyna, '00-'17 Softail, and '99-'16 Touring and Trike models.

Model Family Fitment:

V-ROD
  SPORTSTER
  DYNA
  SOFTAIL
  TOURING



# 464 ENGINE TRIM

Chrome Hardware

## A. WINDSHIELD ACORN NUT KIT

Kit contains 10 chrome-plated low crown 12-24 acorn nuts.

**94111-95**

Fits Compact, King-Size, Convertible and Road King® windshields (pkg. of 10).

## B. CHROME ACORN NUT KITS

**94116-93T** 10 – 32 thread (pkg. of 5).

**94117-93T** 1/4" – 20 thread (pkg. of 5).

**94119-93T** 5/16" – 18 thread (pkg. of 4).

**94120-93T** 5/16" – 24 thread (pkg. of 4).

**94121-93T** 3/8" – 16 thread (pkg. of 3).

**94122-93T** 3/8" – 24 thread (pkg. of 3).

**94124-93T** 7/16" – 20 thread (pkg. of 2).

**94125-93T** 1/2" – 13 thread (pkg. of 1).

**94126-93T** 1/2" – 20 thread (pkg. of 1).

**94127-93T** 5/8" – 18 thread (pkg. of 1).



A. WINDSHIELD ACORN NUT KIT



B. CHROME ACORN NUT KITS

## C. CHROME TORX® BUTTON HEAD SCREWS

Available in 1/4-inch, 5/16-inch and 3/8-inch coarse thread, up to 2-1/4 inches long. Grade 8. See your Dealer for more information.



C. CHROME TORX BUTTON HEAD SCREWS

## D. CHROME HEX SOCKET BUTTON HEAD SCREWS

Available in 8-32, 10-24, 10-32, 1/4-inch, 5/16-inch and 3/8-inch, up to 1 inch long. See your Dealer for more information.



D. CHROME HEX SOCKET BUTTON HEAD SCREWS

## E. CHROME TORX SOCKET HEAD SCREWS

Available in 1/4-inch, 5/16-inch and 3/8-inch coarse thread, up to 2-1/4 inches long. Grade 8. See your Dealer for more information.



E. CHROME TORX SOCKET HEAD SCREWS

## F. CHROME SOCKET HEAD SCREWS

Available in 1/4-inch, 5/16-inch and 3/8-inch coarse and fine thread, up to 3 inches long. See your Dealer for more information.



F. CHROME SOCKET HEAD SCREWS



G. CHROME SMOOTH SOCKET HEAD SCREWS



H. CHROME HEX HEAD SCREWS



I. CHROME 12-POINT SCREWS



J. CHROME FLAT-HEAD SCREWS



K. CHROME LOCK NUTS WITH NYLON INSERTS



L. CHROME HEX NUTS



M. CHROME FLAT WASHERS



N. CHROME LOCK WASHERS

# ENGINE TRIM 465

Chrome Hardware

## G. CHROME SMOOTH SOCKET HEAD SCREWS

Available in 1/4-inch, 5/16-inch and 3/8-inch coarse and fine thread, up to 3 inches long. See your Dealer for more information.

## H. CHROME HEX HEAD SCREWS

Available in 1/4-inch, 5/16-inch and 3/8-inch coarse and fine thread, up to 3 inches long. See your Dealer for more information.

## I. CHROME 12-POINT SCREWS

Available in 1/4-inch, 5/16-inch and 3/8-inch coarse thread, up to 2-1/4 inches long. Grade 8. See your Dealer for more information.

## J. CHROME FLAT-HEAD SCREWS

When the details matter, even your screws are chromed. These Grade 8 Hex Drive screws are available in 17 different sizes. See your Dealer for more information.

## K. CHROME LOCK NUTS WITH NYLON INSERTS

Available in 10-24, 1/4-inch, 5/16-inch, 3/8-inch, 7/16-inch and 5/8-inch sizes, coarse and fine thread. See your Dealer for more information.

## L. CHROME HEX NUTS

Available in 1/4-inch, 5/16-inch and 3/8-inch sizes, coarse and fine thread. See your Dealer for more information.

## M. CHROME FLAT WASHERS

Available in 1/4-inch, 5/16-inch and 3/8-inch sizes. See your Dealer for more information.

## N. CHROME LOCK WASHERS

Available in 1/4-inch, 5/16-inch and 3/8-inch sizes. See your Dealer for more information.

Model Family Fitment:

V-ROD   
  SPORTSTER   
  DYNA  
 SOFTAIL   
  TOURING